

KALEIDOS[®]



**PROFILI IN SINTONIA CON LE PIÙ EVOLUTE TENDENZE
DELL'ARCHITETTURA E DELL'INTERIOR DESIGN.**

PROFILES IN HARMONY WITH THE MOST ADVANCED TRENDS
IN ARCHITECTURE AND INTERIOR DESIGN.

PROFILÉS EN ACCORD AVEC LES TENDANCES LES PLUS ÉVOLUÉES
DE L'ARCHITECTURE ET DU DESIGN D'INTÉRIEUR.

PROFILE IM EINKLANG MIT DEN MODERNSTEN TRENDS
DER ARCHITEKTUR UND DES INTERIOR DESIGNS.



INDICE

INDICE - INDEX - INDEX - INHALTSVERZEICHNISS



INNOVATIVE BY NATURE	05
INTRODUZIONE - INTRODUCTION INTRODUCTION - EINFÜHRUNG	07
CARATTERISTICHE - CHARACTERISTICS CARACTÉRISTIQUES - EIGENSCHAFTEN	08
GAMMA COLORI - COLOUR RANGE GAMME DE COULEURS - FARBPALETTE	12
MOOD	16
BAGNO - BATHROOM SALLE DE BAIN - BADEZIMMER	24
SOGGIORNO - LIVING ROOM SÉJOUR - WOHNZIMMER	34
CAMERA DA LETTO - BEDROOM CHAMBRE - SCHLAFZIMMER	40
SOGGIORNO + BATTISCOPA - LIVING ROOM + SKIRTING BOARD SÉJOUR + PLINTE - SOCKELLEISTEN INNENBEREICH	46
ESTERNO - OUTDOOR EXTÉRIEUR - AUSSENBEREICH	56
INFORMAZIONI TECNICHE - TECHNICAL INFORMATION INFORMATIONS TECHNIQUES - TECHNISCHE INFORMATIONEN	62

40+

ANNI DI ATTIVITÀ
YEARS OF ACTIVITY - ANNÉES D'ACTIVITÉ - ÜBER 40 JAHRE ERFAHRUNG

4

SEDI NEL MONDO
BRANCHES IN THE WORLD - FILIALES DANS LE MONDE - INTERNATIONALE STANDORTE

1

ACCADEMIA / CENTRO DI FORMAZIONE
ACADEMY / TRAINING CENTER - ACADÉMIE / CENTRE DE FORMATION - AKADEMIE & SCHULUNGSZENTRUM

22.000M²

DI STABILIMENTI
A FACTORY - D'USINES - PRODUKTIONSFLÄCHE

60%

ENERGIA DA FONTI RINNOVABILI
ENERGY FROM RENEWABLE SOURCES - ÉNERGIE PROVENANT DE SOURCES RENOUVELABLES - ENERGIE AUS ERNEUERBAREN QUELLEN

90

PAESI SERVITI
COUNTRIES SERVED - PAYS DESSERVIS - WELTWEIT BELIEFERTE LÄNDER

220

DIPENDENTI
EMPLOYEES - EMPLOYÉS - MITARBEITER

120

PROFESSIONISTI TECNICO COMMERCIALI
SALES AND TECHNICAL ENGINEERS - PROFESSIONNELS TECHNIQUES COMMERCIAUX - TECHNISCHE UND KAUFMÄNNISCHE FACHBERATER

6.000

CLIENTI ATTIVI
ACTIVE CUSTOMERS - CLIENTS ACTIFS - AKTIVE KUNDEN WELTWEIT

30

BREVETTI
PATENTS - BREVETS - PATENTE

PROGRESS PROFILES

INNOVATIVE BY NATURE

Da oltre quarant'anni esploriamo nuove frontiere del design, con una visione costantemente proiettata al futuro. Progress Profiles trasforma il sapere produttivo in visione: ricerca, tecnologia e forma si integrano in soluzioni che ridefiniscono il modo di vivere e progettare gli spazi.

Innovazione, qualità e sostenibilità orientano ogni scelta, in un equilibrio dinamico tra sensibilità estetica e precisione industriale. Per noi, guardare oltre non è solo un obiettivo: è nella nostra natura.

For over forty years we have been exploring new frontiers of design, with a vision constantly projected into the future. Progress Profiles transforms productive knowledge into vision: research, technology, and form integrate into solutions that redefine the way we live and design spaces. Innovation, quality and sustainability guide every choice, in a dynamic balance between aesthetic sensitivity and industrial precision. For us, looking beyond is not just a goal: it is in our nature.

Depuis plus de quarante ans, nous explorons de nouvelles frontières du design, avec une vision constamment projetée vers l'avenir. Progress Profiles transforme le savoir productif en vision : recherche, technologie et forme s'intègrent dans des solutions qui redéfinissent la façon de vivre et de concevoir les espaces. L'innovation, la qualité et le développement durable guident chaque choix, dans un équilibre dynamique entre sensibilité esthétique et précision industrielle. Pour nous, aller au-delà n'est pas seulement un objectif : c'est dans notre nature.

Seit über vierzig Jahren erkunden wir neue Grenzen des Designs – mit einer Vision, die stets auf die Zukunft ausgerichtet ist. Progress Profiles verwandelt Produktionskompetenz in Vision: Forschung, Technologie und Form verbinden sich zu Lösungen, die die Art und Weise, wie Räume gestaltet und erlebt werden, neu definieren. Innovation, Qualität und Nachhaltigkeit prägen jede unserer Entscheidungen – in einem dynamischen Gleichgewicht zwischen ästhetischem Gespür und industrieller Präzision. Für uns ist der Blick über den Horizont hinaus nicht nur ein Ziel – er ist Teil unserer Natur.

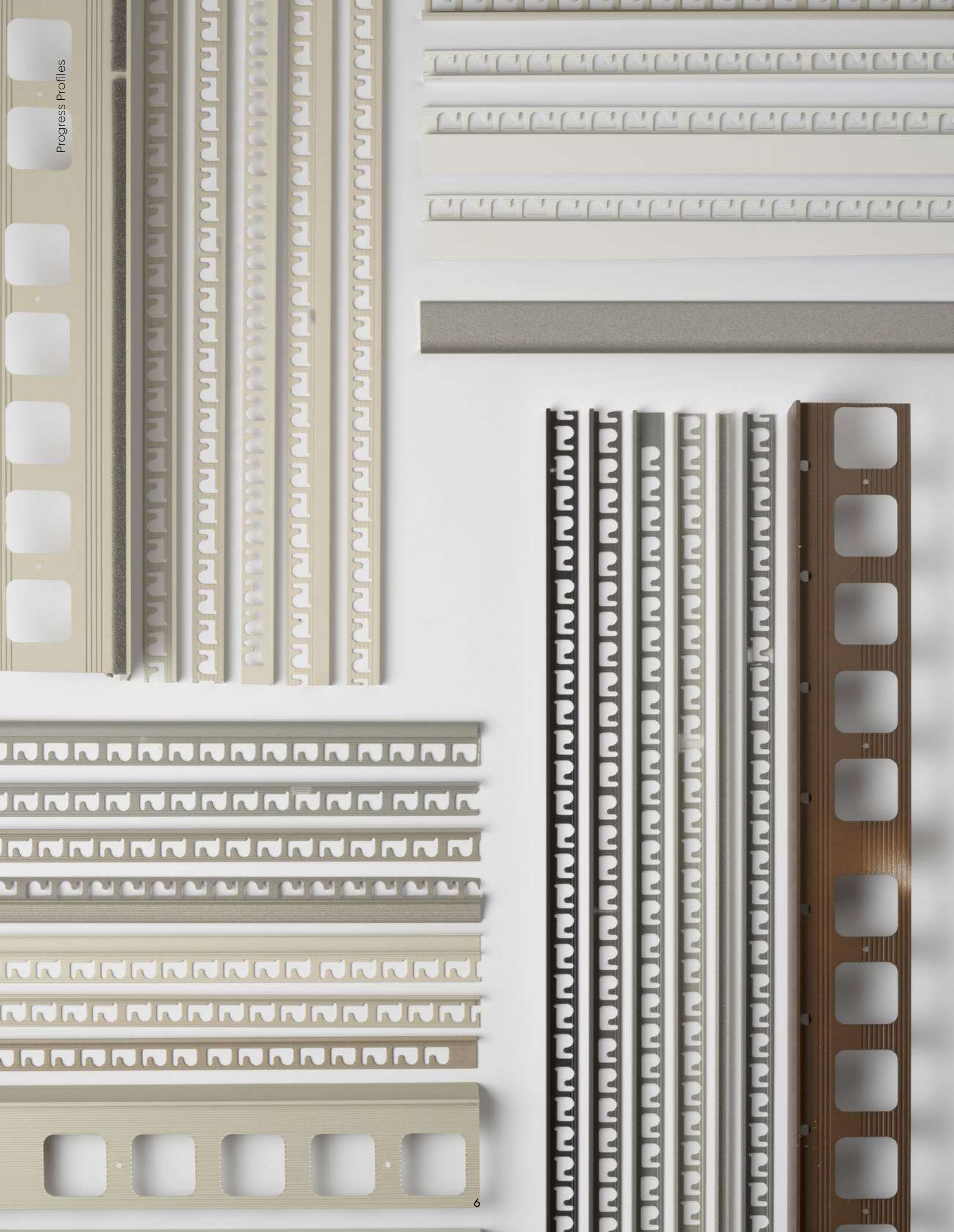

KALEIDOS®

GUARDANDO ALLE MILLE SFUMATURE DEL DESIGN

Kaleidos è l'interpretazione di Progress Profiles del design contemporaneo, un dialogo perfetto tra materiali, finiture e forme. Texture materiche che richiamano gli effetti pietra si combinano in un equilibrio cromatico dinamico, mentre i profili diventano veri e propri segni architettonici, capaci di trasformare ogni spazio in un'esperienza unica. Ogni dettaglio racconta una visione, ogni linea genera emozione. Kaleidos è il perfetto abbinamento con le ceramiche di tendenza e con i Total look, offrendo soluzioni coerenti e armoniche in ogni ambiente. Non è solo design: è un nuovo modo di guardare e vivere lo spazio, dove estetica, funzione e sensibilità contemporanea si incontrano in armonia.

Kaleidos è un nuovo sguardo sul design contemporaneo.

LOOKING AT THE THOUSAND NUANCES OF DESIGN

Kaleidos is Progress Profiles interpretation of contemporary design, a perfect dialogue between materials, finishes and shapes. Material textures that recall stone effects combine in a dynamic chromatic balance, while the profiles become true architectural signs, capable of transforming each space into a unique experience. Every detail tells a vision, every line generates emotion. Kaleidos is the perfect match with trendy ceramics and total looks, offering consistent and harmonious solutions in every environment. It is not just design: it is a new way of looking at and experiencing space, where aesthetics, function, and contemporary sensitivity meet in harmony.

Kaleidos is a new look at contemporary design.

EN REGARDANT LES MILLE NUANCES DU DESIGN

Kaleidos est l'interprétation de Progress Profiles du design contemporain, un dialogue parfait entre matériaux, finitions et formes. Les textures de matériaux qui rappellent les effets pierre se combinent dans un équilibre chromatique dynamique, tandis que les profilés deviennent de véritables signes architecturaux, capables de transformer chaque espace en une expérience unique. Chaque détail raconte une vision, chaque ligne génère de l'émotion. Kaleidos est la combinaison parfaite avec les céramiques de tendance et avec les total looks, offrant des solutions cohérentes et harmonieuses dans chaque environnement. Il ne s'agit pas seulement de design : c'est une nouvelle façon de regarder et de vivre l'espace, où esthétique, fonction et sensibilité contemporaine se rencontrent en harmonie.

Kaleidos est un nouveau regard sur le design contemporain.

MIT BLICK AUF DIE VIELFÄLTIGEN FACETTEN DES DESIGNS

Kaleidos ist die Interpretation von Progress Profiles des zeitgenössischen Designs – ein perfekter Dialog zwischen Materialien, Oberflächen und Formen. Materialbetonte Texturen mit Steineffekt verbinden sich zu einem dynamischen Farbgleichgewicht, während die Profile zu echten architektonischen Elementen werden, die jeden Raum in ein einzigartiges Erlebnis verwandeln können. Jedes Detail erzählt eine Vision, jede Linie erzeugt Emotion. Kaleidos ist die perfekte Ergänzung zu trendiger Keramik und zu Total-Look-Konzepten und bietet stimmige und harmonische Lösungen für jeden Raum. Es ist nicht nur Design – es ist eine neue Art, Raum zu sehen und zu erleben, in der Ästhetik, Funktion und zeitgenössische Sensibilität harmonisch zusammenkommen.

Kaleidos ist ein neuer Blick auf das zeitgenössische Design.

FINITURE IDEATE PER DISTINGUERSI,
SVILUPPATE PER DURARE

FINISHES DESIGNED TO STAND OUT,
DEVELOPED TO LAST

FINITIONS CONÇUES POUR SE DÉMARQUER,
DÉVELOPPÉES POUR DURER

OBERFLÄCHEN, DIE ENTWICKELT WURDEN,
UM SICH ABZUHEBEN – UND UM DAUERHAFT ZU BESTEHEN

CARATTERISTICHE
CHARACTERISTICS - CARACTÉRISTIQUES - EIGENSCHAFTEN

1

GAMMA PREMIUM DI FINITURE ESTETICHE E TECNICHE
PREMIUM RANGE OF AESTHETIC AND TECHNICAL FINISHES - GAMME PREMIUM DE FINITIONS ESTHÉTIQUES ET TECHNIQUE
PREMIUM-PROGRAMM MIT ÄSTHETISCHEN UND TECHNISCHEN OBERFLÄCHEN.

2

PROGRAMMA COMPLETO: 29 PROFILI E ACCESSORI COORDINATI
COMPLETE PROGRAM: 29 PROFILES AND ACCESSORIES COORDINATED - PROGRAMME COMPLET : 29 PROFILÉS ET ACCESSOIRES COORDONNÉS
KOMPLETTES PROGRAMM: 29 PROFILFORMEN UND PASSENDE ZUBEHÖRTEILE

3

OLTRE 2.000 CODICI, LA GAMMA PIÙ AMPIA SUL MERCATO
WITH OVER 2,000 CODES, THE WIDEST RANGE ON THE MARKET - PLUS DE 2 000 CODES, LA GAMME LA PLUS LARGE DU MARCHÉ
ÜBER 2.000 ARTIKEL – DIE BREITESTE PRODUKTPALETTE AUF DEM MARKT

4

TECNOLOGIA AVANZATA PER FINITURE SUPERFICIALI DI ALTA QUALITÀ
ADVANCED TECHNOLOGY FOR HIGH-QUALITY SURFACE FINISHES - TECHNOLOGIE AVANCÉE POUR LES FINITIONS DE SURFACE DE HAUTE QUALITÉ
FORTSCHRITTLICHE TECHNOLOGIE FÜR HOCHWERTIGE OBERFLÄCHE

5

ALTA RESISTENZA A NEBBIA SALINA E AMBIENTI AGGRESSIVI
HIGH RESISTANCE TO SALT SPRAY AND AGGRESSIVE ENVIRONMENTS - HAUTE RÉSISTANCE AU BROUILLARD SALIN ET AUX ENVIRONNEMENTS AGRESSIFS
HOHE BESTÄNDIGKEIT GEGEN SALZNEBEL UND AGGRESSIVE UMGEBUNGEN

6

TEXTURE TRIDIMENSIONALE PER MAGGIORE RESISTENZA ALL'ABRASIONE
THREE-DIMENSIONAL TEXTURE FOR INCREASED ABRASION RESISTANCE - TEXTURE TRIDIMENSIONNELLE POUR UNE MEILLEURE RÉSISTANCE À L'ABRASION.
DREIDIMENSIONALE TEXTUR FÜR HÖHERE ABRIEBFESTIGKEIT



La finitura KALEIDOS prevede verniciatura in polvere poliestere con processo certificato QUALICOAT, che garantisce elevata durata, stabilità cromatica e uniformità estetica. Il rivestimento offre ottima resistenza ai graffi, alla corrosione filiforme e agli ambienti con presenza di cloro, come piscine e centri benessere. Disponibile in un'ampia gamma di colori coordinabili con ceramiche e superfici moderne. I profili verniciati rispettano le tolleranze previste dalla UNI EN 120202, assicurando precisione e qualità costante.

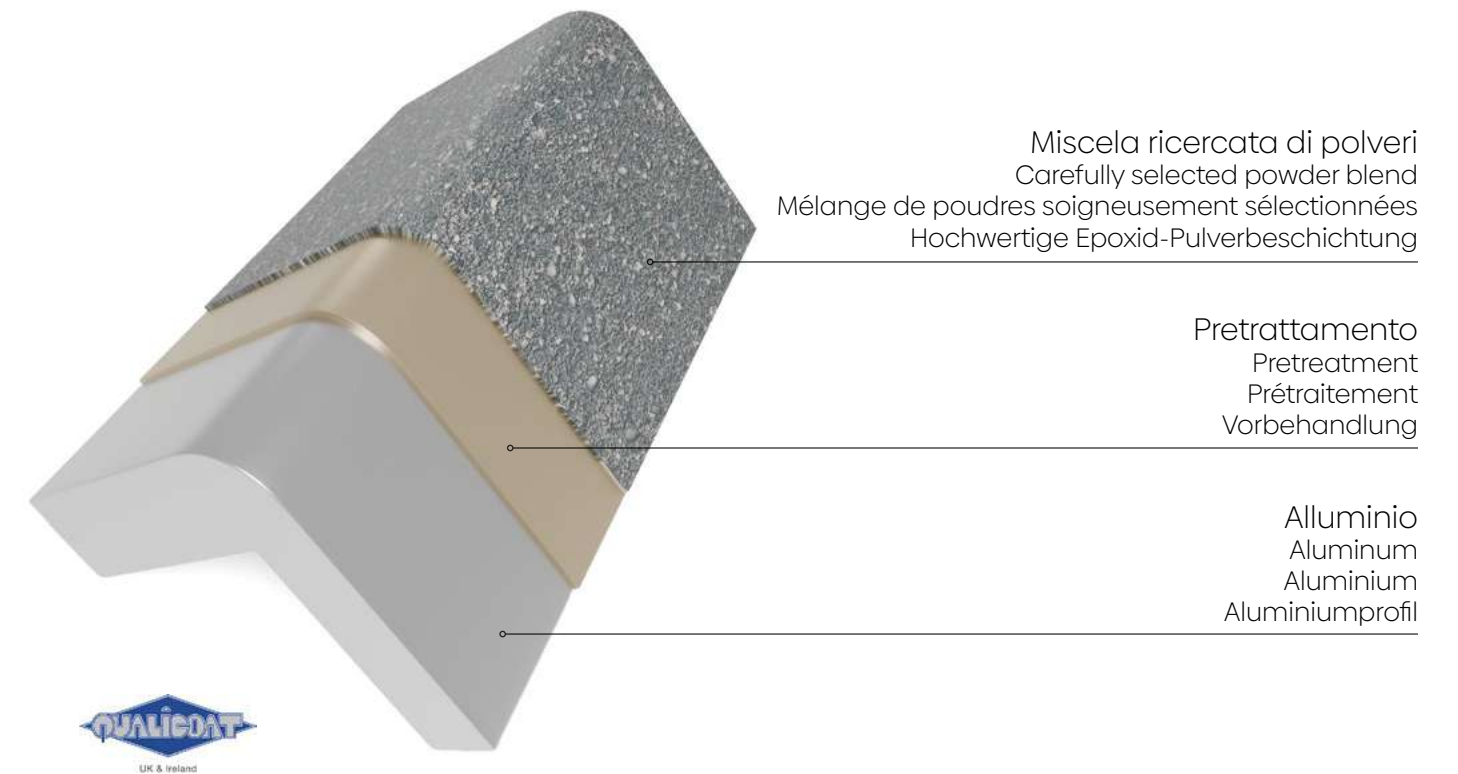

The KALEIDOS finish features polyester powder coating with a QUALICOAT certified process, which guarantees high durability, colour stability and aesthetic uniformity. The coating offers excellent resistance to scratches, thread-like corrosion, and chlorine-containing environments, such as swimming pools and spas. Available in a wide range of colours that can be coordinated with modern ceramics and surfaces. The painted profiles comply with the tolerances provided for by UNI EN 120202, ensuring precision and constant quality.

La finitura KALEIDOS prévoit un revêtement en poudre polyester avec le procédé certifié QUALICOAT, qui garantit une grande durabilité, une stabilité chromatique et une uniformité esthétique. Le revêtement offre une excellente résistance aux rayures, à la corrosion filiforme et aux environnements avec présence de chlore, comme les piscines et les centres de bien-être. Disponible dans une large gamme de couleurs assorties à la céramique et aux surfaces modernes. Les profils peints respectent les tolérances prévues par la norme UNI EN 120202, assurant précision et qualité constante.

Die KALEIDOS-Oberfläche ist eine Epoxid/Polyester-Pulverbeschichtung mit QUALICOAT-zertifizierung, das eine hohe Dauerhaftigkeit, Farbstabilität und ein gleichmäßiges Erscheinungsbild gewährleistet. Die Beschichtung bietet eine extreme Beständigkeit gegen Kratzer, filiforme Korrosion und ist für die Verwendung in Umgebungen mit Chlorbelastung, wie z.B. in Schwimmbädern und Wellnessbereichen geeignet. Kaleidos ist in einer breiten Farbpalette erhältlich, die sich ideal mit Keramik und modernen Oberflächen kombinieren lässt. Die lackierten Profile entsprechen die Norm UNI EN 12020-2 und gewährleisten Präzision und gleichbleibend hohe Qualität.

KALEIDOS Stone Line

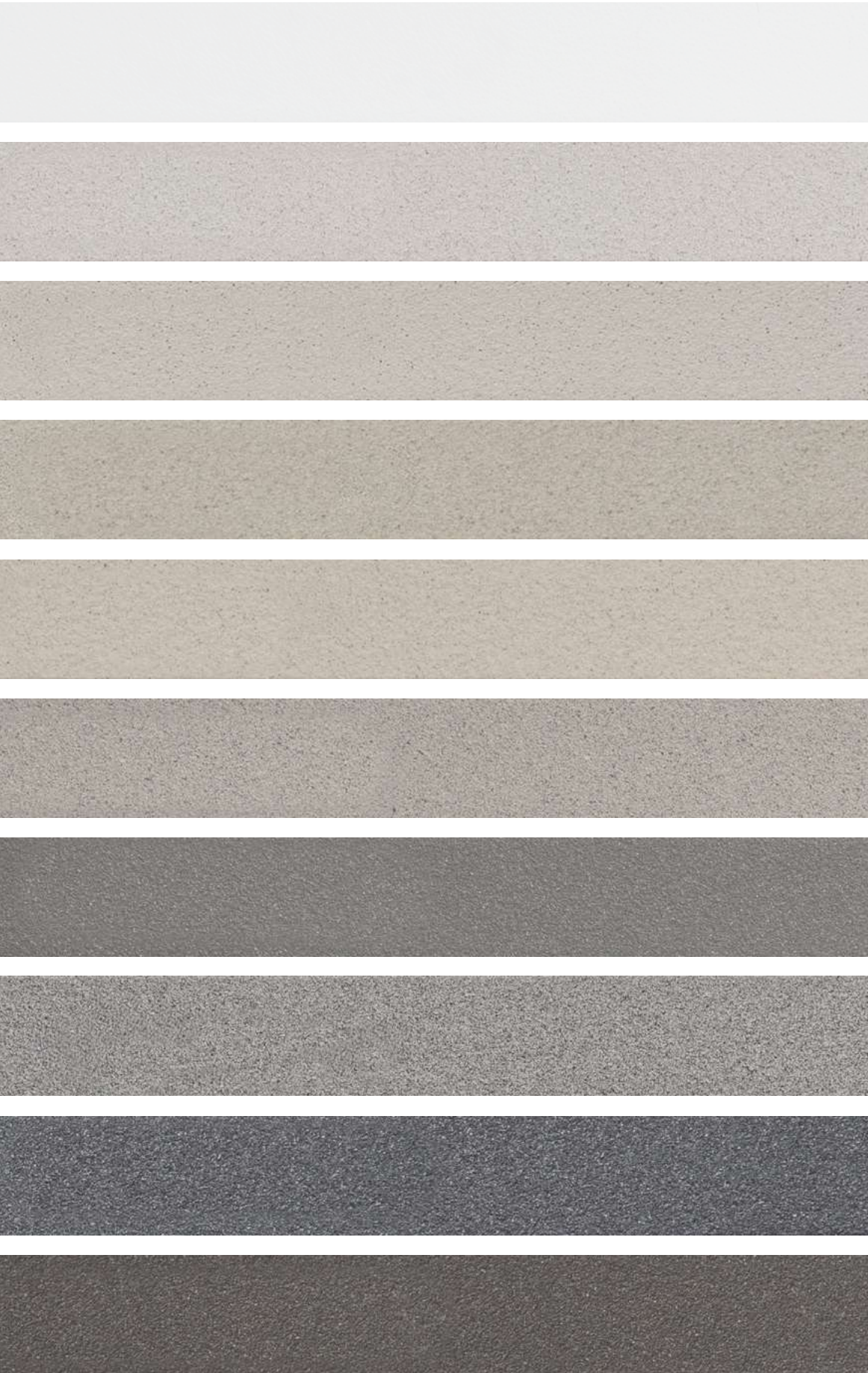

SL01
Stone white

SL18
Stone white cement

SL03
Stone greyvory

SL04
Stone sand

SL02
Stone cream

SL06
Stone cristal gray

SL13
Stone oyster grey

SL05
Stone gray

SL07
Stone antragray

SL16
Stone grey gun

SL14
Stone taupe gray

SL15
Stone grey smoke

SL09
Stone bronze

SL17
Stone tobacco

SL08
Stone antradark

SL12
Stone black

SL19
Stone sahara

SL10
Stone corten

SL20
Stone cement grey

SL21
Stone blue grey

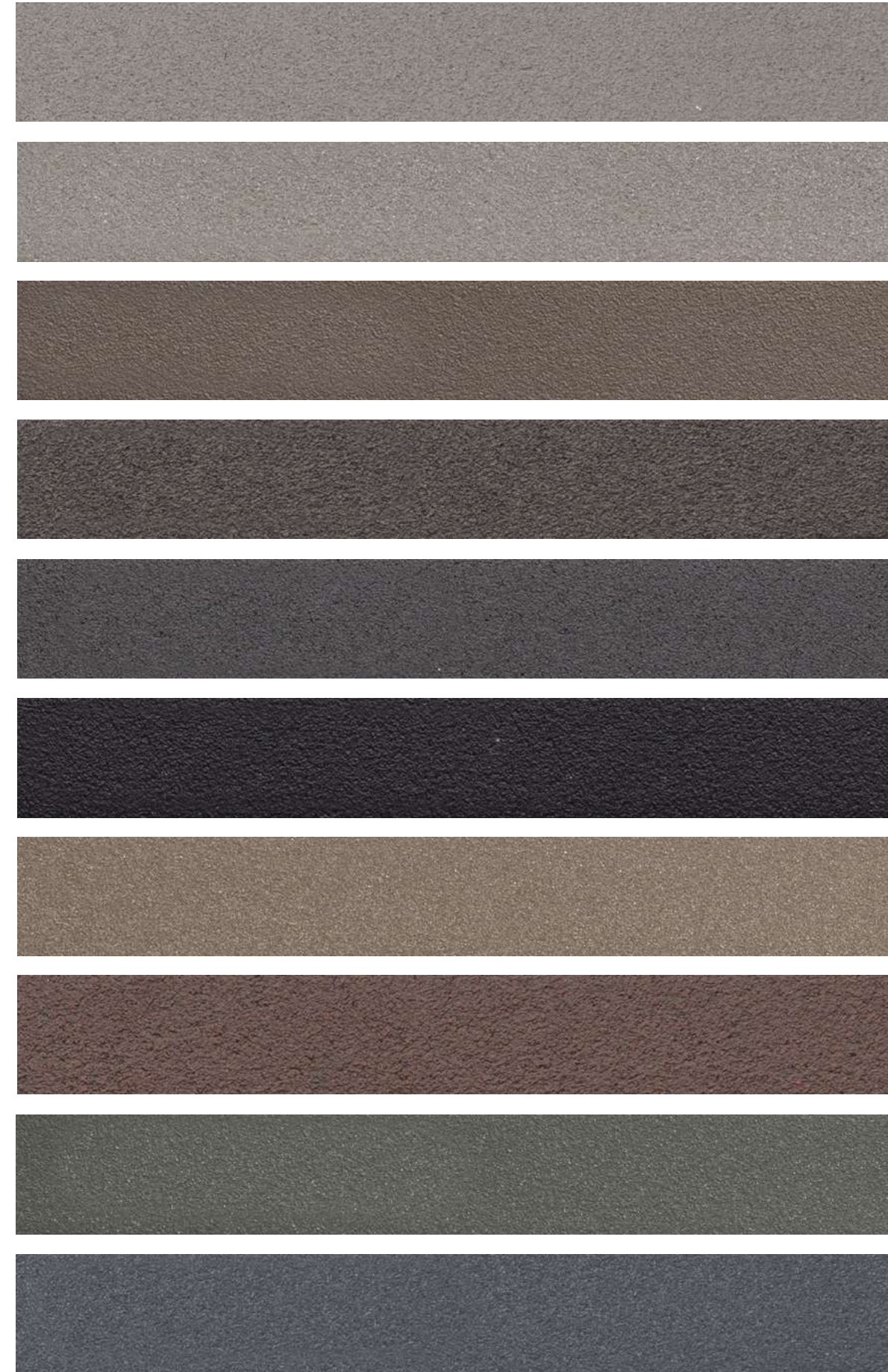

KALEIDOS Easy Line



EYP01
Easy matt white

EY109
Easy warm grey

EY007
Easy beige

EY151
Easy hazel brown

EY110
Easy dark beige

EY006
Easy light grey

EY008
Easy dark grey

EYP11
Easy matt black

KALEIDOS EASY LINE

KALEIDOS EASY è la proposta dal design semplice ed immediato, pensata per i progetti di tutti i giorni, che consente facili abbinamenti con i colori degli stucchi. Le superfici uniformi richiamano l'effetto delle fughe ceramiche contribuendo a creare continuità visiva ed alta resa estetica, senza rinunciare alla qualità tipica della gamma **KALEIDOS**

Kaleidos è un nuovo sguardo sul design contemporaneo: un approccio che supera la materia per trasformarla in elemento progettuale distintivo, capace di dialogare con lo spazio e valorizzarne l'identità con naturalezza.

KALEIDOS EASY is the proposal with simple and immediate design, ideal for everyday projects, which allows easy combinations with the colours of the stucco. The uniform surfaces recall the effect of ceramic joints helping to create visual continuity and high aesthetic yield, without sacrificing the quality typical of the **KALEIDOS** range.

Kaleidos is a new look at contemporary design: an approach that transcends matter to transform it into a distinctive design element, capable of engaging with space and naturally enhancing its identity.

KALEIDOS EASY est la proposition au design simple et immédiat, pensée pour les projets de tous les jours, qui permet des combinaisons faciles avec les couleurs des stucs. Les surfaces uniformes rappellent l'effet des joints céramiques contribuant à créer une continuité visuelle et un rendu esthétique élevé, sans renoncer à la qualité typique de la gamme **KALEIDOS**.

Kaleidos est un nouveau regard sur le design contemporain : une approche qui dépasse la matière pour la transformer en élément de projet distinctif, capable de dialoguer avec l'espace et de valoriser son identité avec naturel.

KALEIDOS EASY ist das Konzept einem einfachen und unmittelbaren Design, entwickelt für alltägliche Projekte und für einfache Farbkombinationen mit den Fugen. Die gleichmäßigen Oberflächen erinnern an den Effekt keramischer Fugen und schaffen visuelle Kontinuität sowie eine hochwertige ästhetische Wirkung, ohne auf die typische Qualität der **KALEIDOS**-Serie zu verzichten.

Kaleidos ist ein neuer Blick auf das zeitgenössische Design: ein Ansatz, der über das Material hinaus es zu einem prägenden Gestaltungselement macht, das mit dem Raum in Dialog tritt und seine Identität auf natürliche Weise hervorhebt.

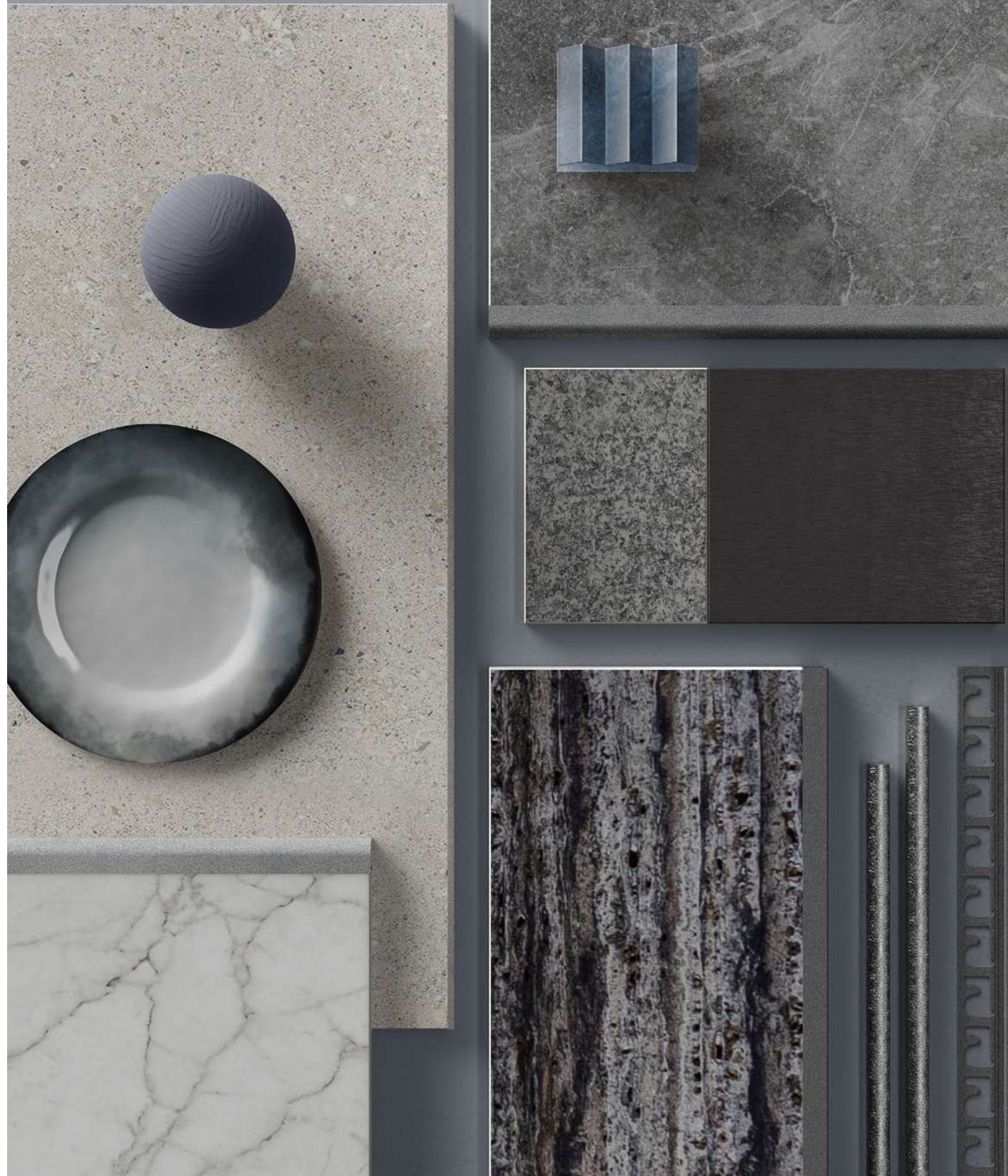

NORDIC WHISPER MOOD

Un sussurro di pace che richiama le atmosfere del Nord. Toni freddi e superfici materiche si fondono in un equilibrio armonioso, dove il rigore dei profili si sposa con l'aspetto naturale delle lastre ceramiche. Un design per spazi che invitano alla calma e alla contemplazione.

A whisper of peace that recalls the atmospheres of the North. Cold tones and material surfaces blend in a harmonious balance, where the rigor of the profiles marries with the natural appearance of the ceramic slabs. A design for spaces that invite calm and contemplation.

Un murmure de paix qui rappelle les atmosphères du Nord. Les tons froids et les surfaces matérielles se fondent dans un équilibre harmonieux, où la rigueur des profilés se marie avec l'aspect naturel des plaques céramiques. Un design pour des espaces invitant au calme et à la contemplation.

Ein Hauch von Ruhe, inspiriert von den Atmosphären des Nordens. Kühle Farbtöne und materische Oberflächen kombinieren sich zu einem harmonischen Gleichgewicht, in dem die klare Linie der Profile mit dem natürlichen Charakter keramischer Platten zusammenkommt. Ein Design für Räume, die zur Ruhe und Kontemplation einladen.

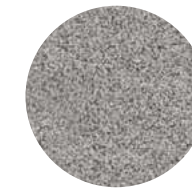

SLO5
Stone gray

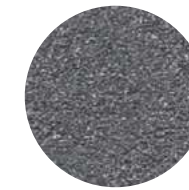

SLO7
Stone antragr

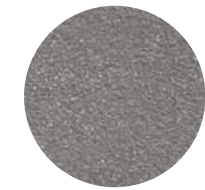

SL13
Stone oyster grey



PROTERMINAL



PROJOLLY SQUARE



PROJOLLY QUART



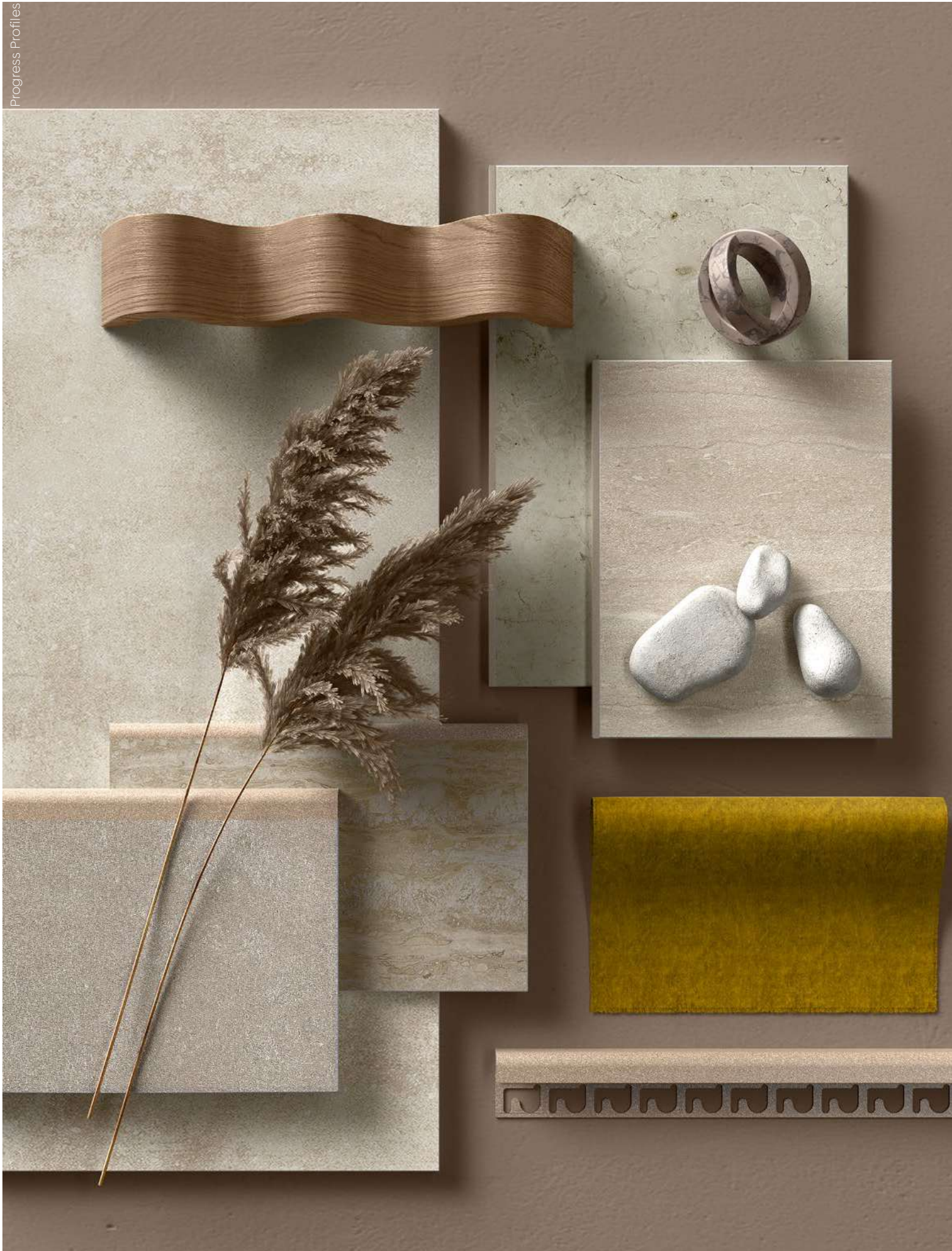

MINIMAL ESSENCE MOOD

L'essenza del design ridotta alla sua forma più pura. Una palette calda e neutra trova abbinamenti a contrasto per ambienti luminosi, celebrando la bellezza della semplicità. Profili discreti valorizzano ogni dettaglio, definendo spazi dove ogni elemento trasmette ordine e serenità.

The essence of design reduced to its purest form. A warm, neutral palette finds contrasting pairings for bright environments, celebrating the beauty of simplicity. Discrete profiles enhance every detail, defining spaces where each element conveys order and serenity.

L'essence du design réduite à sa forme la plus pure. Une palette chaude et neutre trouve des combinaisons de contraste pour les environnements lumineux, célébrant la beauté de la simplicité. Les profilés discrets mettent en valeur chaque détail, définissant des espaces où chaque élément transmet ordre et sérénité.

Der Kern des Designs, reduziert auf seine reinste Form. Eine warme und neutrale Farbpalette findet kontrastreiche Kombinationen für helle Räume und feiert die Schönheit der Einfachheit. Dezenste Profile heben jedes Detail hervor und definieren Räume, in denen jedes Element Ordnung und Ruhe vermittelt.

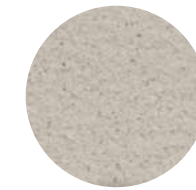

SL02
Stone cream

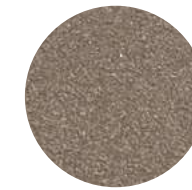

SL19
Stone sahara



PROTERMINAL



PROJOLLY QUART





MODERN CONTEMPORARY MOOD

Una visione contemporanea che unisce dinamismo e luminosità. I colori chiari delle ceramiche di design dialogano con le perfette simmetrie dei profili metallici, assecondando le tendenze architettoniche più attuali, per ambienti moderni dallo stile pulito e armonioso.

A contemporary vision that combines dynamism and luminosity. The light colours of the designer ceramics dialogue with the perfect symmetries of the metal profiles, following the most current architectural trends, for modern environments with a clean and harmonious style.

Une vision contemporaine qui allie dynamisme et luminosité. Les couleurs claires des céramiques de design dialoguent avec les symétries parfaites des profilés métalliques, suivant les tendances architecturales les plus actuelles, pour des environnements modernes au style épuré et harmonieux.

Eine zeitgenössische Vision, die Dynamik und Helligkeit vereint. Die hellen Farben von Designkeramik treten in Dialog mit den perfekten Symmetrien der Profile und greifen die aktuellsten architektonischen Trends auf – für moderne Räume mit klarem und harmonischem Stil.



SLO1
Stone white

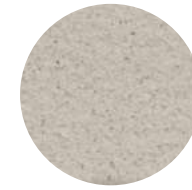

SLO2
Stone cream

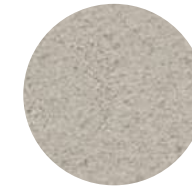

SLO4
Stone sand



SLO6
Stone cristal gray



SL18
Stone white cement

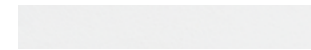

PROTERMINAL



PROJOLLY SQUARE

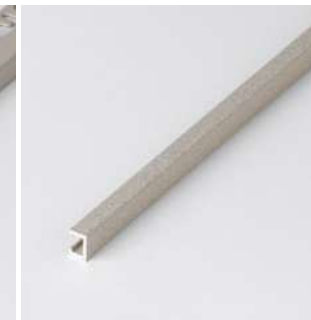

PROLISTEL P ALL

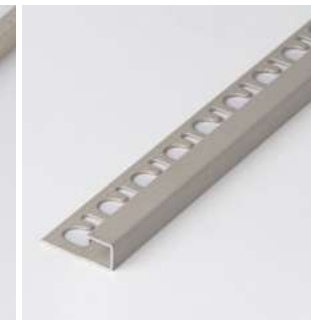

PROJOLLY SQUARE



PROJOLLY SQUARE





WARM ATMOSPHERE MOOD

Un abbraccio avvolgente di tonalità profonde e naturali. Nuance a contrasto creano atmosfere sofisticate. Profili dal design raffinato incorniciano come fossero quadri le lastre ceramiche, in ambienti eleganti dal fascino senza tempo.

An enveloping embrace of deep, natural shades. Contrasting nuances create sophisticated atmospheres. Profiles of refined design frame the ceramic slabs as if they were paintings, in elegant environments with timeless charm.

Une étreinte enveloppante de teintes profondes et naturelles. Des nuances contrastées créent des atmosphères sophistiquées. Des profilés au design raffiné encadrent comme des tableaux les plaques de céramique, dans des environnements élégants au charme intemporel.

Eine umhüllende Umarmung mit Kräftigen und natürlichen Farbtönen. Gegensätzliche Nuancen schaffen eine raffinierte Atmosphäre. Profile mit elegantem Design rahmen die keramischen Platten wie Bilder ein - in stilvollen Räumen mit zeitlosem Charme.

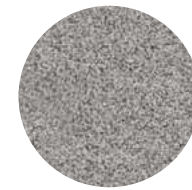

SLO5
Stone gray

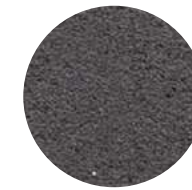

SLO8
Stone antradark

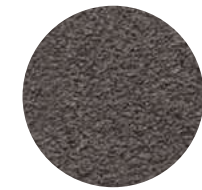

SL17
Stone tobacco



PROTERMINAL



PROJOLLY SQUARE



PROJOLLY QUART





Prolistel P all

Proniche flex 120

Projolly quart

Proshell

Projolly square

Proniche flex 60

Prolistel channel

Proshelf ins

Proshower profile
glass, wall, front

Proniche flex 30

Projolly quart

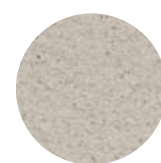

SLO2
Stone cream



Projolly square

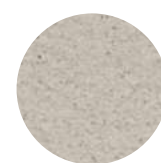

SLO2
Stone cream



VARIAZIONI CROMATICHE - CHROMATIC VARIATIONS - VARIATIONS CHROMATIQUES - FARBKOMBINATIONEN



SLO1
Stone white



SLO6
Stone cristal gray



SLO4
Stone sand



SL19
Stone sahara

VARIAZIONI CROMATICHE - CHROMATIC VARIATIONS - VARIATIONS CHROMATIQUES - FARBKOMBINATIONEN



SLO1
Stone white

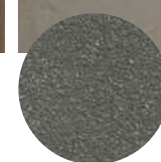

SL20
Stone cement grey



SL18
Stone White Cemet



SL14
Stone taupe grey

Prolistel P all

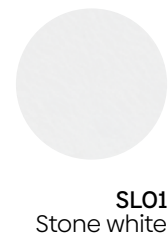

SLO1
Stone white

Proshell all

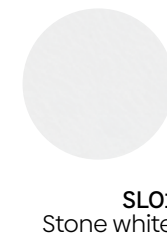

SLO1
Stone white

VARIAZIONI CROMATICHE - CHROMATIC VARIATIONS - VARIATIONS CHROMATIQUES - FARBKOMBINATIONEN

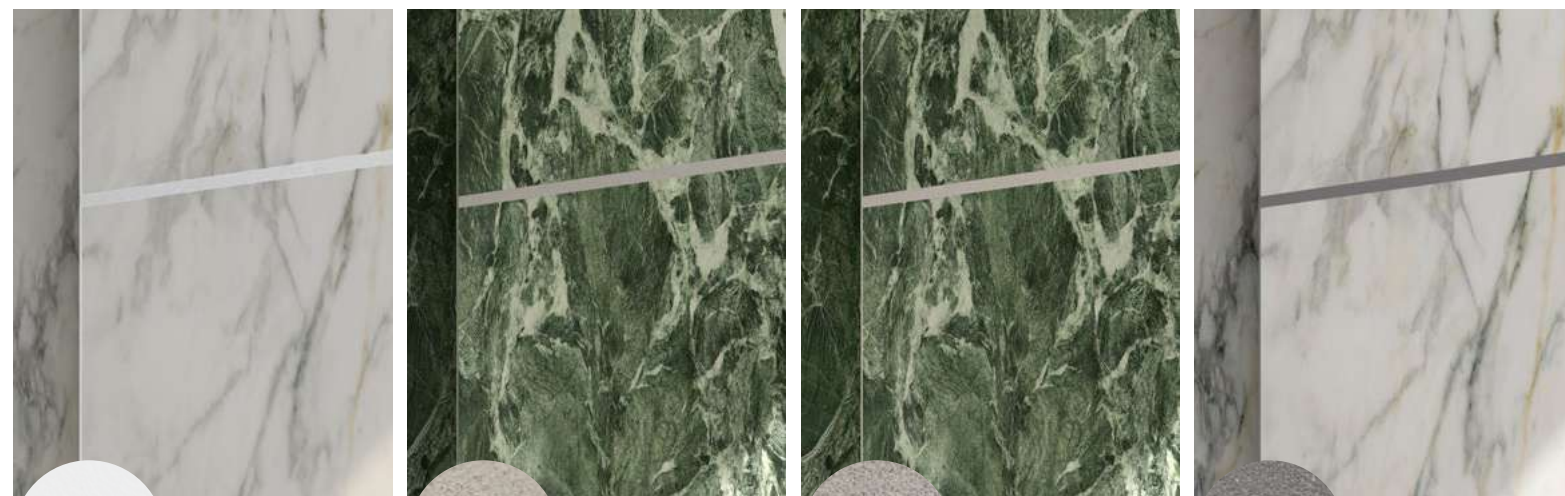

SLO1
Stone white



SLO4
Stone sand



SLO6
Stone cristal grey



SL13
Stone oyster grey

VARIAZIONI CROMATICHE - CHROMATIC VARIATIONS - VARIATIONS CHROMATIQUES - FARBKOMBINATIONEN



SLO4
Stone sand

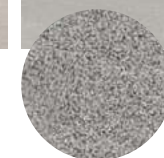

SLO5
Stone gray

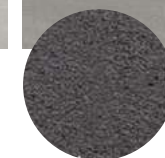

SLO8
Stone antrdark



SLO1
Stone white

Prolistel channel



SLO2
Stone cream

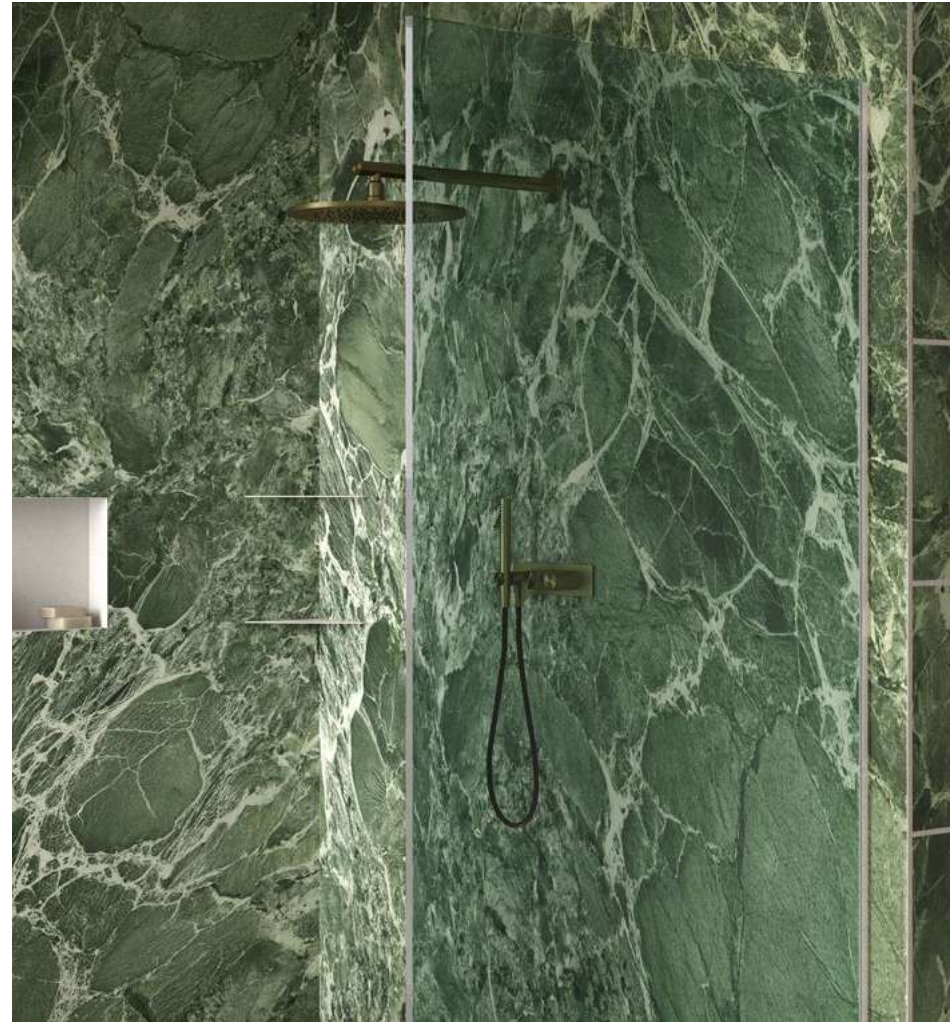

Proshower profiles



Proshower glass

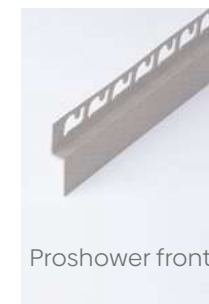

Proshower front

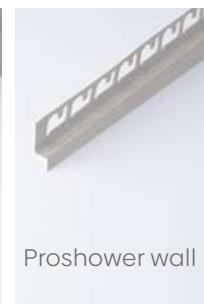

Proshower wall

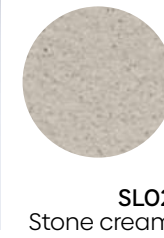

SLO2
Stone cream



VARIAZIONI CROMATICHE - CHROMATIC VARIATIONS - VARIATIONS CHROMATIQUES - FARBKOMBINATIONEN

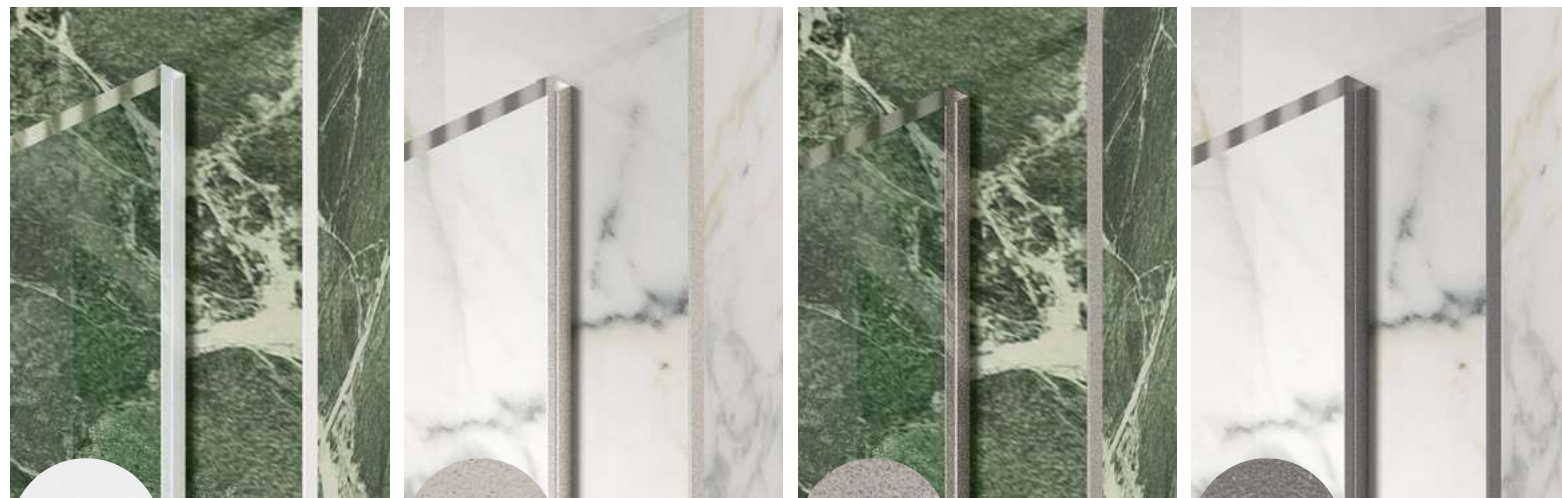

SLO1
Stone white



SLO3
Stone greyyory

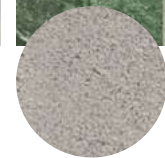

SLO6
Stone cristal grey

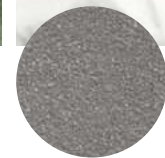

SL13
Stone oyster grey

VARIAZIONI CROMATICHE - CHROMATIC VARIATIONS - VARIATIONS CHROMATIQUES - FARBKOMBINATIONEN



SLO1
Stone white

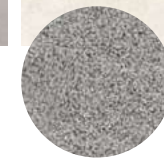

SLO5
Stone gray



SLO8
Stone antradark



SLO4
Stone sand

Proniche flex 30, 60, 120

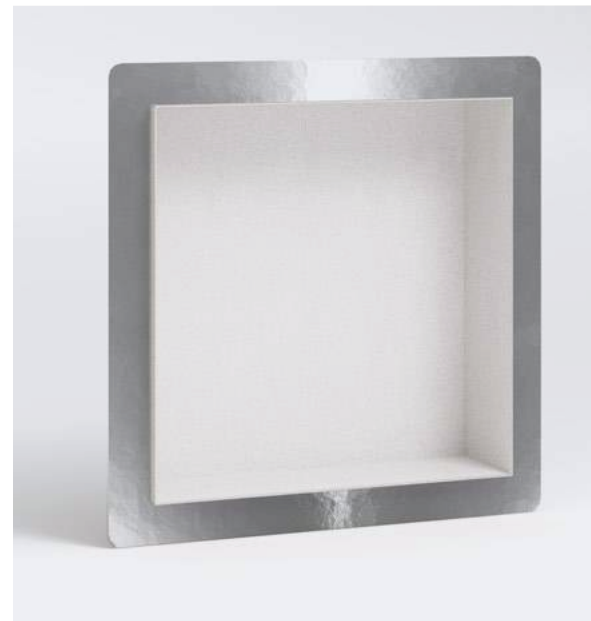

SLO1
Stone white



Proshelf ins line / design

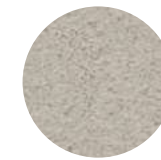

SLO4
Stone sand

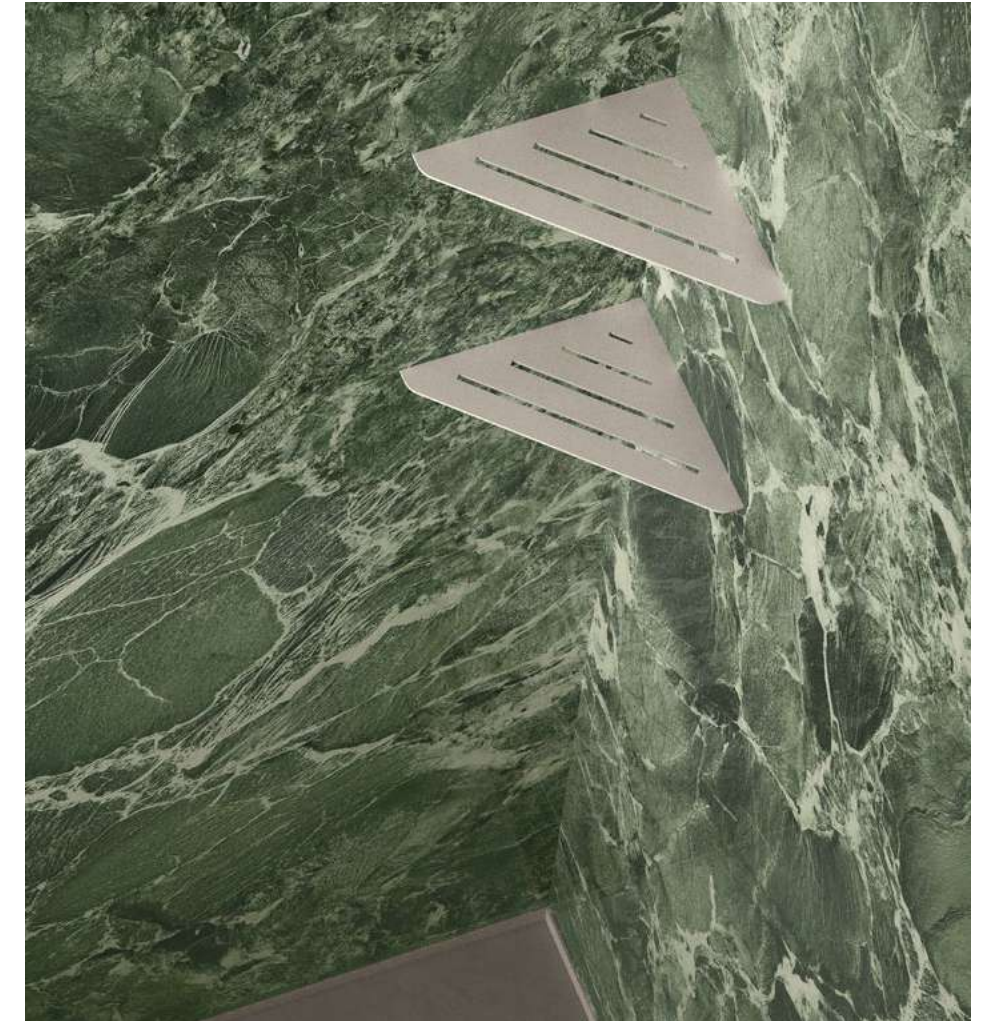

VARIAZIONI CROMATICHE - CHROMATIC VARIATIONS - VARIATIONS CHROMATIQUES - FARBKOMBINATIONEN



SLO4
Stone sand



EYP11
Easy matt black

VARIAZIONI CROMATICHE - CHROMATIC VARIATIONS - VARIATIONS CHROMATIQUES - FARBKOMBINATIONEN

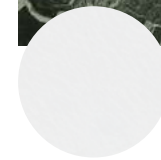
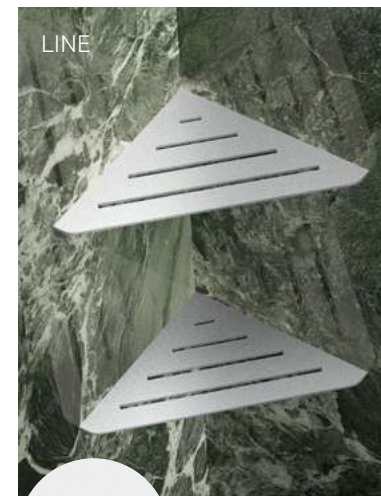

SLO1
Stone white

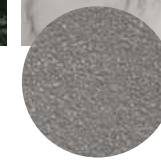

SL13
Stone oyster grey



SLO6
Stone cristal grey

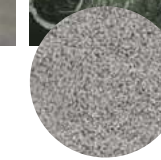
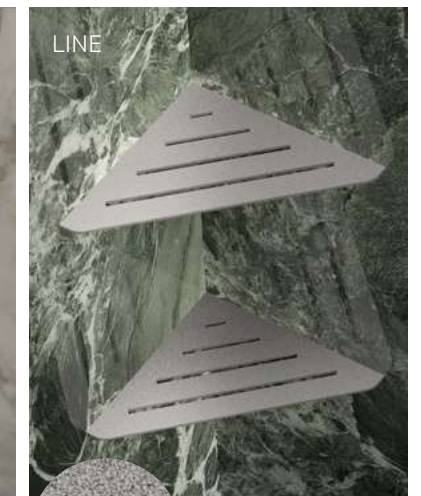

SLO5
Stone gray

Prokerlam line

Proterminal

Proshadow stair&wall

Proterminal

Proshadow stair&wall

Prokerlam line

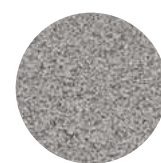

SLO5
Stone gray

Proshadow stair & wall



SL18
Stone white cement

VARIAZIONI CROMATICHE - CHROMATIC VARIATIONS - VARIATIONS CHROMATIQUES - FARBKOMBINATIONEN



SLO1
Stone white



SL18
Stone white cement

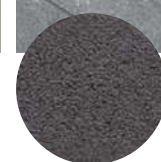

SLO8
Stone antradark



SLO5
Stone gray

VARIAZIONI CROMATICHE - CHROMATIC VARIATIONS - VARIATIONS CHROMATIQUES - FARBKOMBINATIONEN



SLO5
Stone gray



SLO1
Stone white

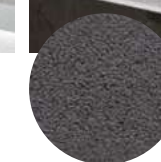

SLO8
Stone antradark



SL18
Stone white cement

Proterminal



SL10
Stone corten



VARIAZIONI CROMATICHE - CHROMATIC VARIATIONS - VARIATIONS CHROMATIQUES - FARBKOMBINATIONEN



SL01
Stone white



SL02
Stone cream



SL04
Stone sand



SL18
Stone white cement

VARIAZIONI CROMATICHE - CHROMATIC VARIATIONS - VARIATIONS CHROMATIQUES - FARBKOMBINATIONEN



SL05
Stone gray

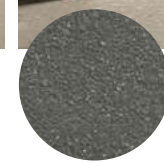

SL20
Stone cement gray



SL08
Stone antradark



SL19
Stone sahara

Proshadow Ceiling

Proshadow stair&wall

Battiscopa 40- 60- 80- 100

Proshadow Ceiling



EYPO1
Easy matt white



Proshadow stair & wall

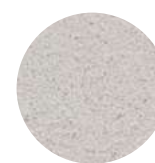

SL18
Stone white cement



VARIAZIONI CROMATICHE - CHROMATIC VARIATIONS - VARIATIONS CHROMATIQUES - FARBKOMBINATIONEN

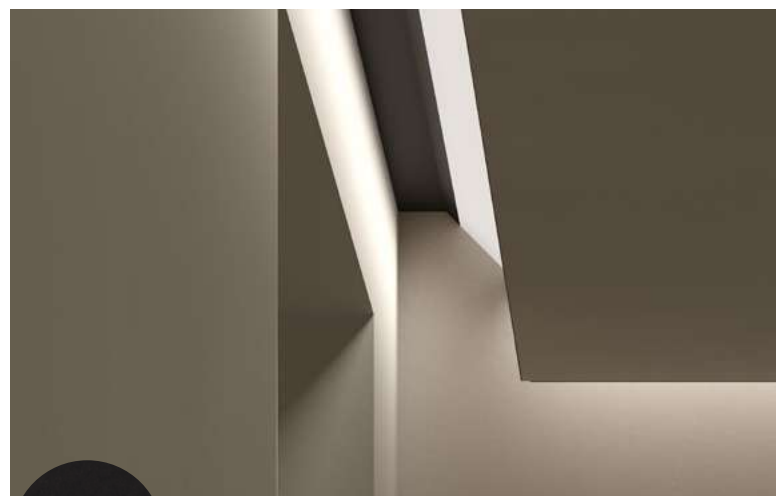

EYP11
Easy matt black

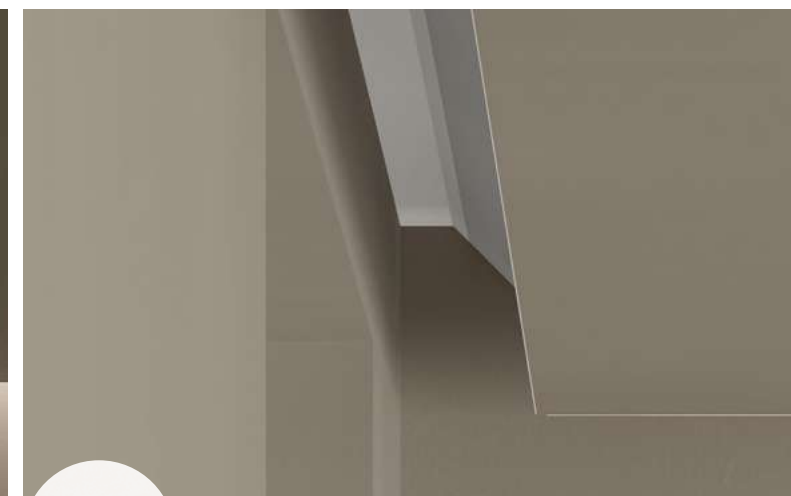

EYPO1
Easy matt white

VARIAZIONI CROMATICHE - CHROMATIC VARIATIONS - VARIATIONS CHROMATIQUES - FARBKOMBINATIONEN



SLO5
Stone gray



SLO1
Stone white



SL18
Stone white cement



SLO8
Stone antradark

Battiscopa 40 - 60 - 80 - 100

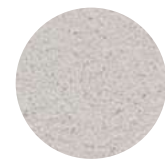

SL18
Stone white cement

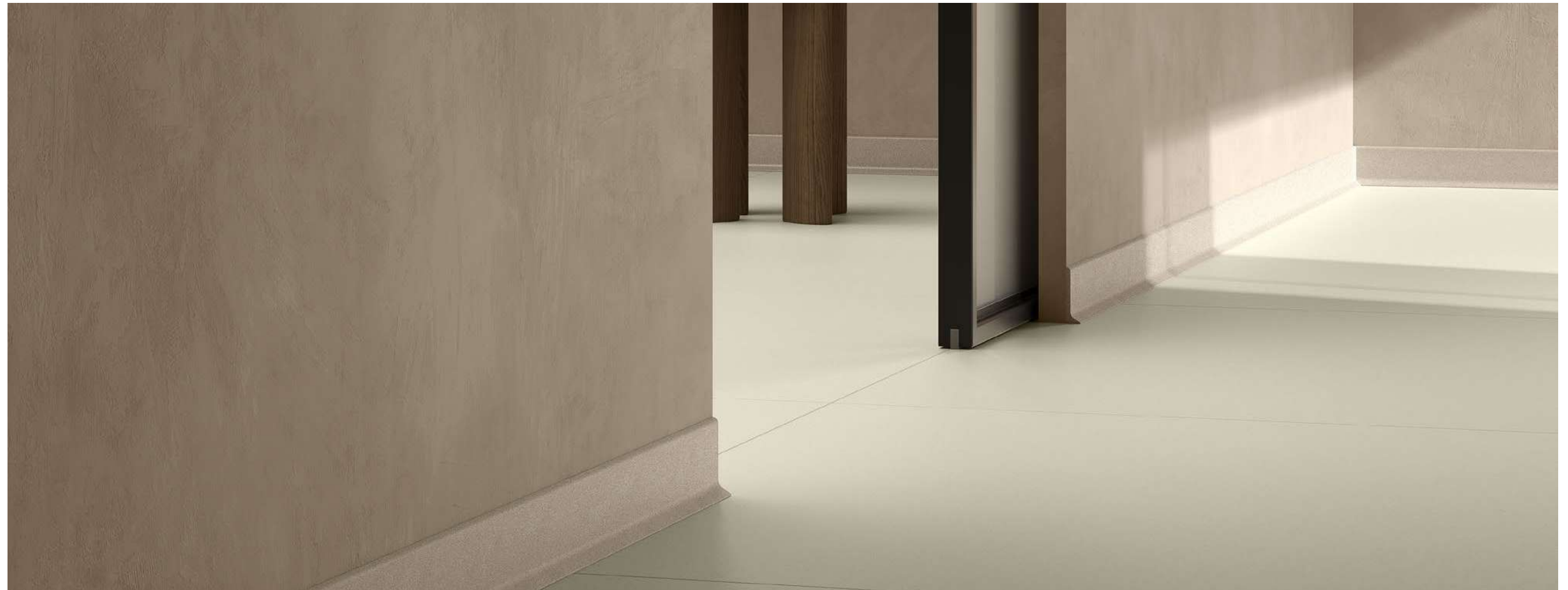

VARIAZIONI CROMATICHE - CHROMATIC VARIATIONS - VARIATIONS CHROMATIQUES - FARBKOMBINATIONEN

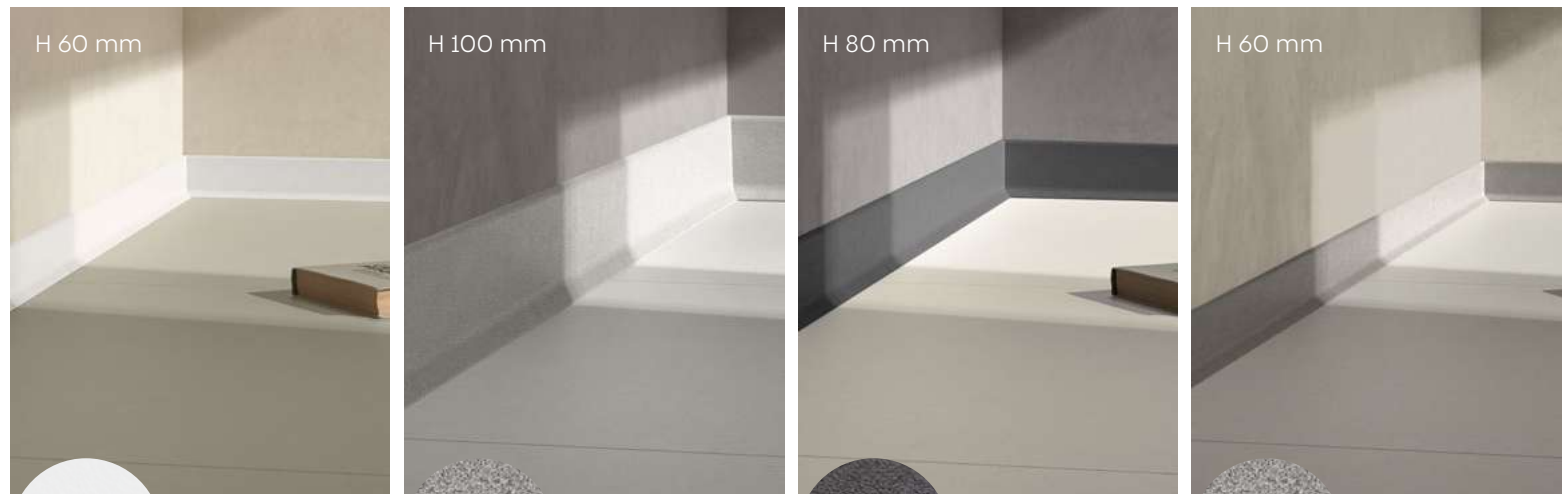

SLO1
Stone white



SLO5
Stone gray

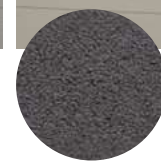

SLO8
Stone antradark

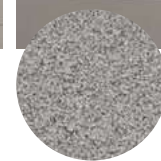

SLO5
Stone gray

VARIAZIONI CROMATICHE - CHROMATIC VARIATIONS - VARIATIONS CHROMATIQUES - FARBKOMBINATIONEN

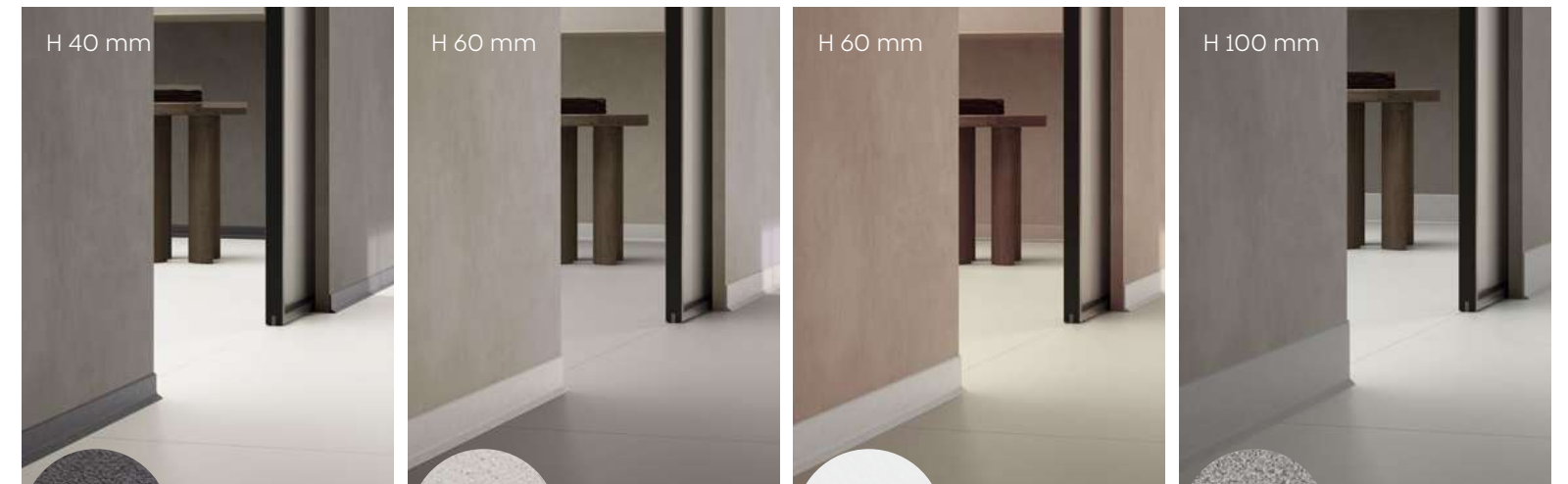

SLO8
Stone antradark

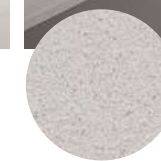

SL18
Stone white cement



SLO1
Stone white

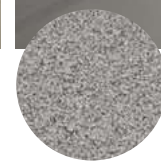

SLO5
Stone gray

Proshadow ceiling

Proshadow gap 2513 / 2520

Proshadow gap 2513 / 2520



EYP01
Easy matt white



Proshadow gap 25

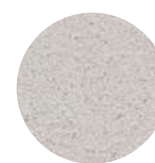

SL18
Stone white cement



VARIAZIONI CROMATICHE - CHROMATIC VARIATIONS - VARIATIONS CHROMATIQUES - FARBKOMBINATIONEN



EYP11
Easy matt black

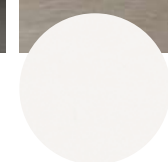

EYP01
Easy matt white

VARIAZIONI CROMATICHE - CHROMATIC VARIATIONS - VARIATIONS CHROMATIQUES - FARBKOMBINATIONEN



EYP11
Easy matt black

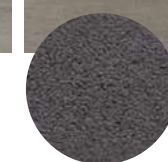

SLO8
Stone antradark



EYP01
Easy matt white



SL18
Stone white cement

Proskirting list 40 - 60 - 80



SL18
Stone white cement

Proskirting round 40 - 60 - 80

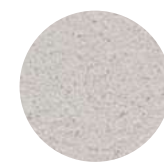

SL18
Stone white cement

VARIAZIONI CROMATICHE - CHROMATIC VARIATIONS - VARIATIONS CHROMATIQUES - FARBKOMBINATIONEN

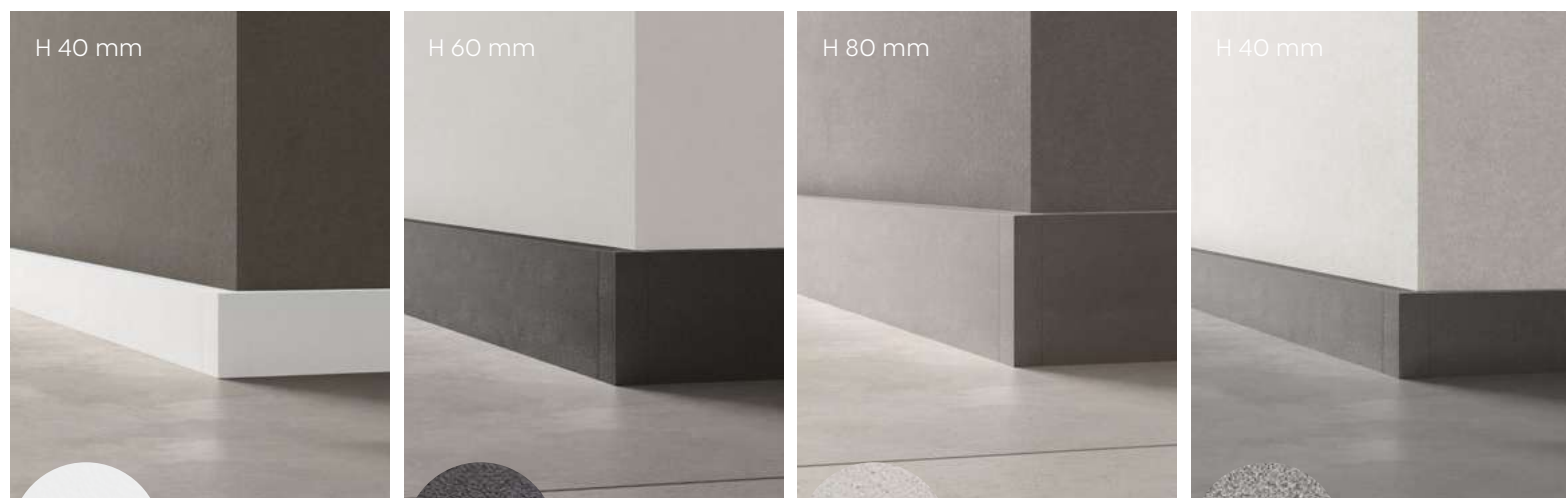

SLO1
Stone white



SLO8
Stone antradark



SL18
Stone white cement

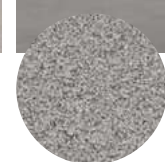

SLO5
Stone gray

VARIAZIONI CROMATICHE - CHROMATIC VARIATIONS - VARIATIONS CHROMATIQUES - FARBKOMBINATIONEN

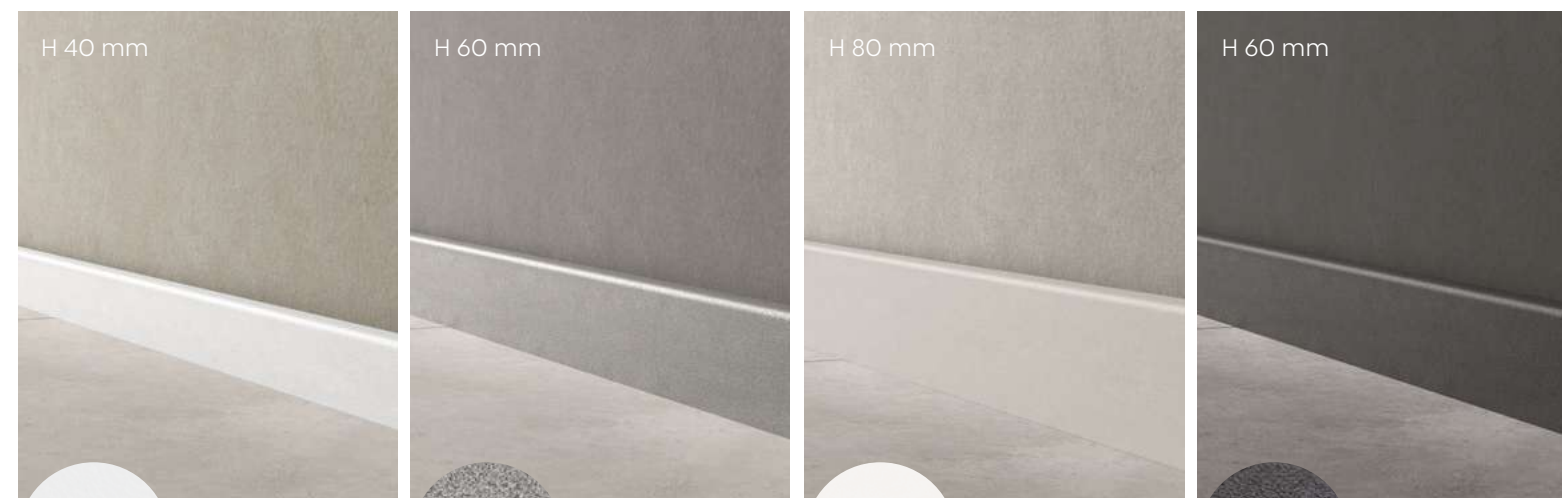

SLO1
Stone white

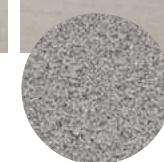

SLO5
Stone gray



EYPO1
Easy matt white

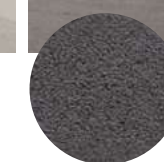

SLO8
Stone antradark

Proskirting flat

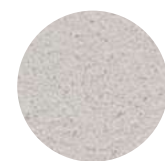

SL18
Stone white cement

Proskirting ins

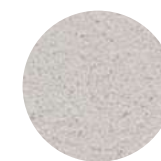

SL18
Stone white cement

VARIAZIONI CROMATICHE - CHROMATIC VARIATIONS - VARIATIONS CHROMATIQUES - FARBKOMBINATIONEN

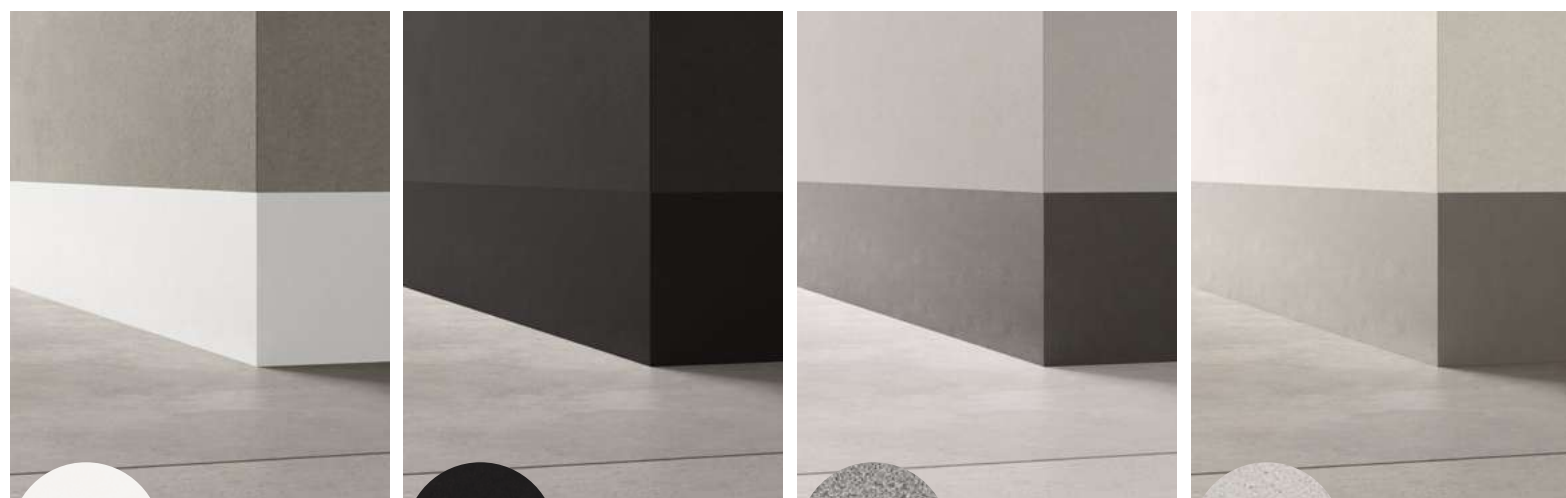

EYPO1
Easy matt white

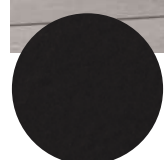

EYP11
Easy matt black



SLO5
Stone gray



SL18
Stone white cement

VARIAZIONI CROMATICHE - CHROMATIC VARIATIONS - VARIATIONS CHROMATIQUES - FARBKOMBINATIONEN

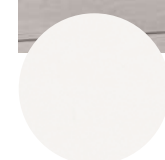
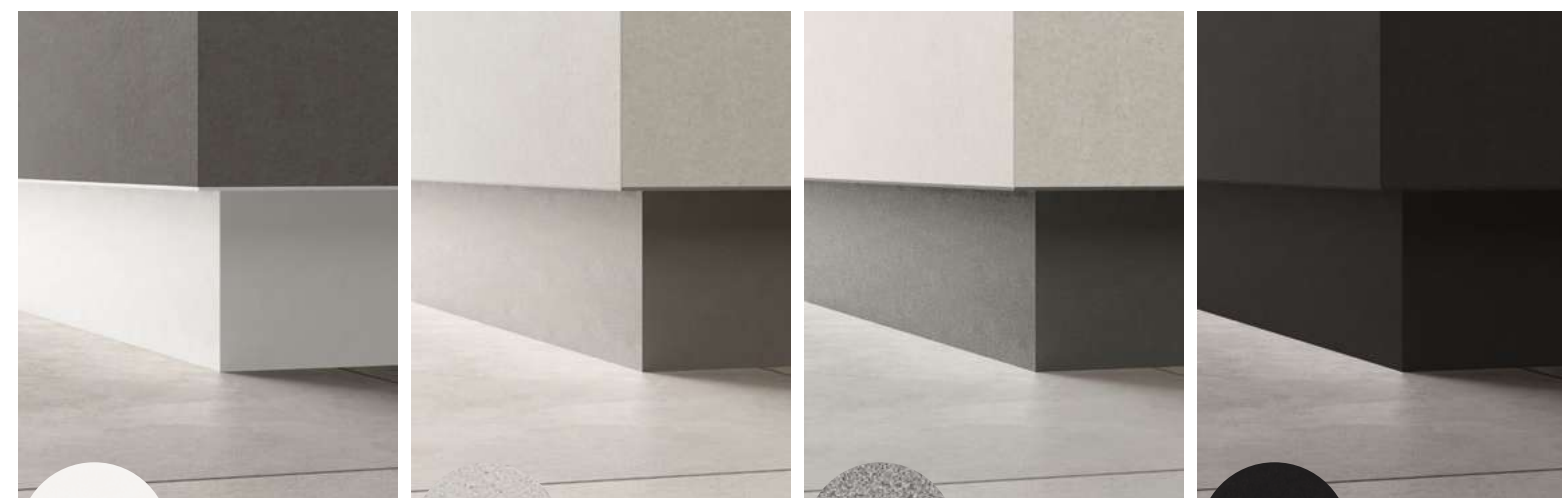

EYPO1
Easy matt white



SL18
Stone white cement

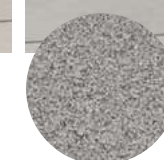

SLO5
Stone gray



EYP11
Easy matt black

Proskirting line

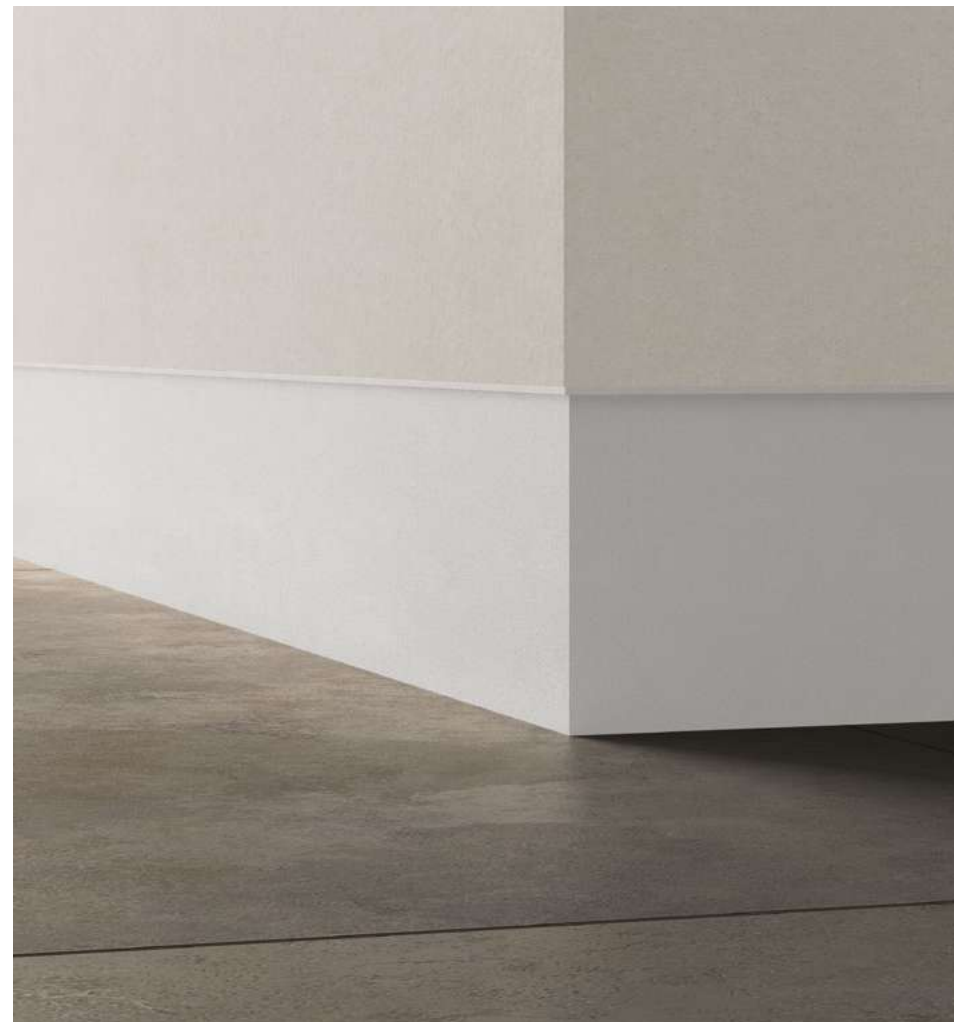

EYP01
Easy matt white

Proskirting 202060



EYP01
Easy matt white

VARIAZIONI CROMATICHE - CHROMATIC VARIATIONS - VARIATIONS CHROMATIQUES - FARBKOMBINATIONEN



EYP11
Easy matt black



EYP01
Easy matt white

VARIAZIONI CROMATICHE - CHROMATIC VARIATIONS - VARIATIONS CHROMATIQUES - FARBKOMBINATIONEN



EYP11
Easy matt black



EYP01
Easy matt white

Proterrace double drip
Proterrace eco drip

Double terminal

Proside walk



Proterrace eco drip

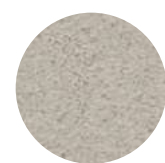

SLO4
Stone sand

Proterrace double drip

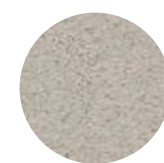

SLO4
Stone sand

VARIAZIONI CROMATICHE - CHROMATIC VARIATIONS - VARIATIONS CHROMATIQUES - FARBKOMBINATIONEN



SLO5
Stone gray

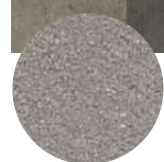

SL15
Stone grey smoke



SL12
Stone black



SL10
Stone corten

VARIAZIONI CROMATICHE - CHROMATIC VARIATIONS - VARIATIONS CHROMATIQUES - FARBKOMBINATIONEN



SLO5
Stone gray

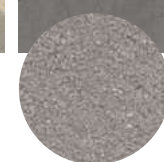

SL15
Stone grey smoke



SL12
Stone black



SL10
Stone corten

Proside walk

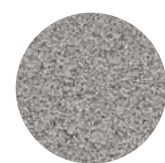
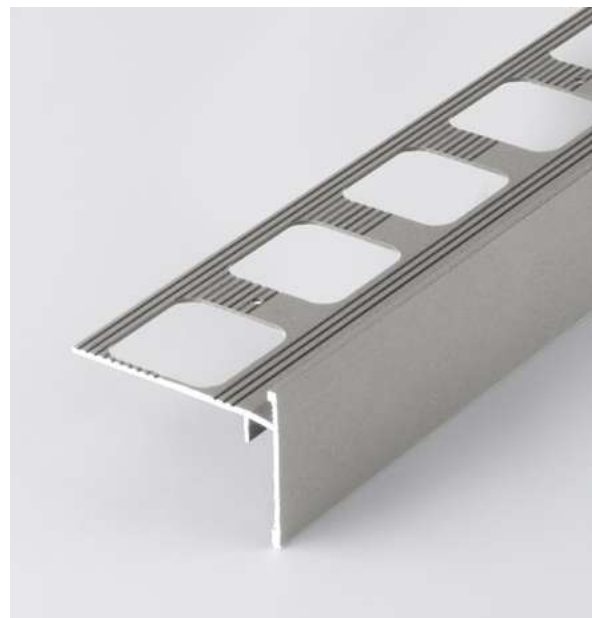

SL05
Stone gray



Double terminal

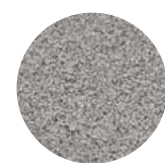
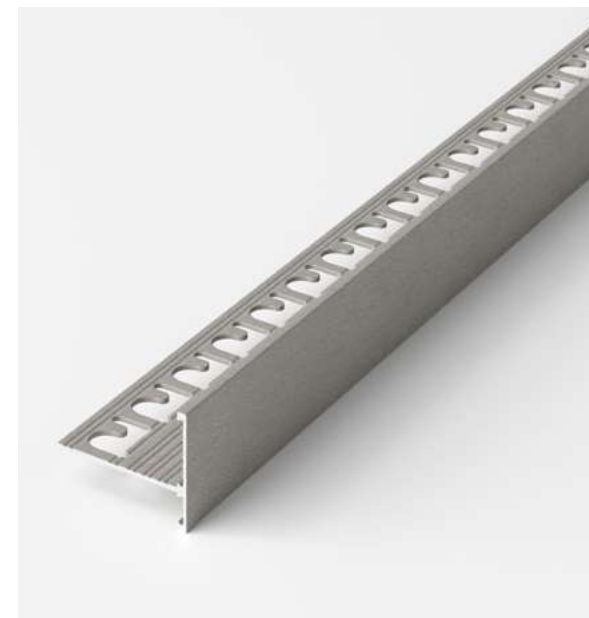

SL05
Stone gray

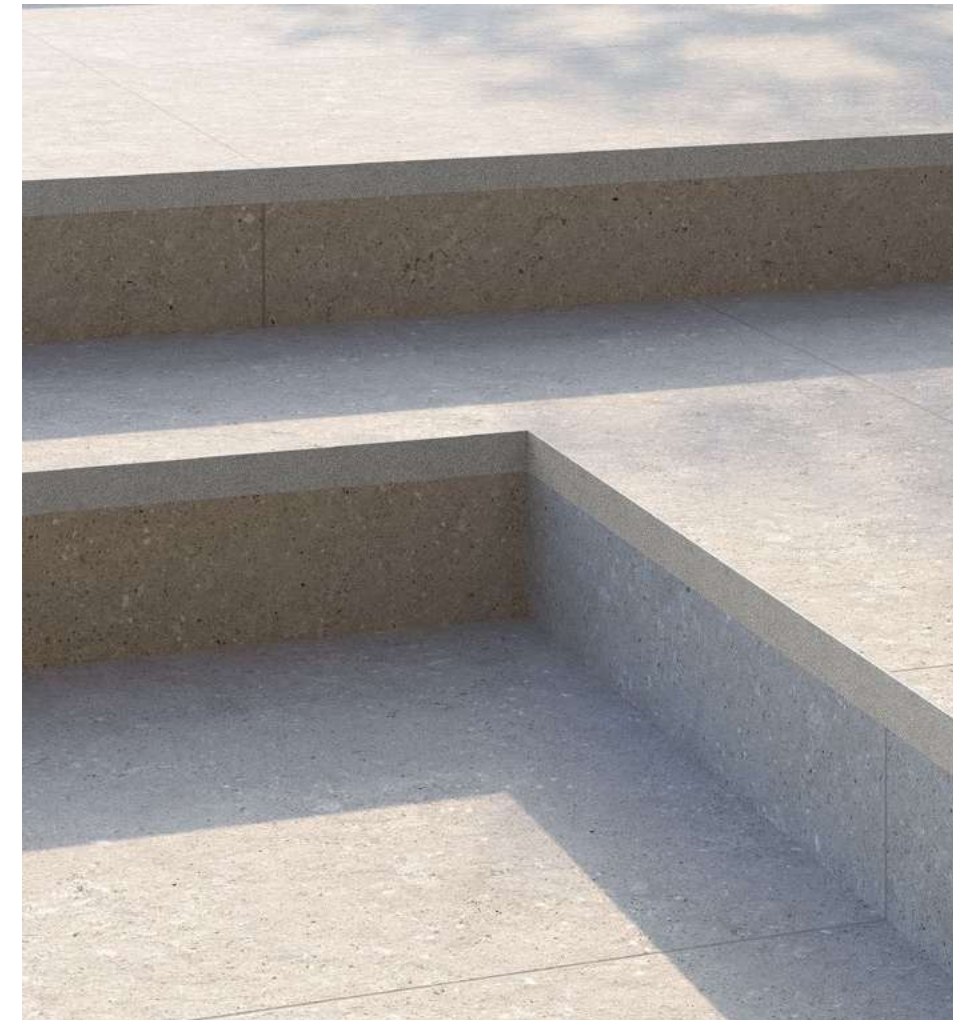

VARIAZIONI CROMATICHE - CHROMATIC VARIATIONS - VARIATIONS CHROMATIQUES - FARBKOMBINATIONEN

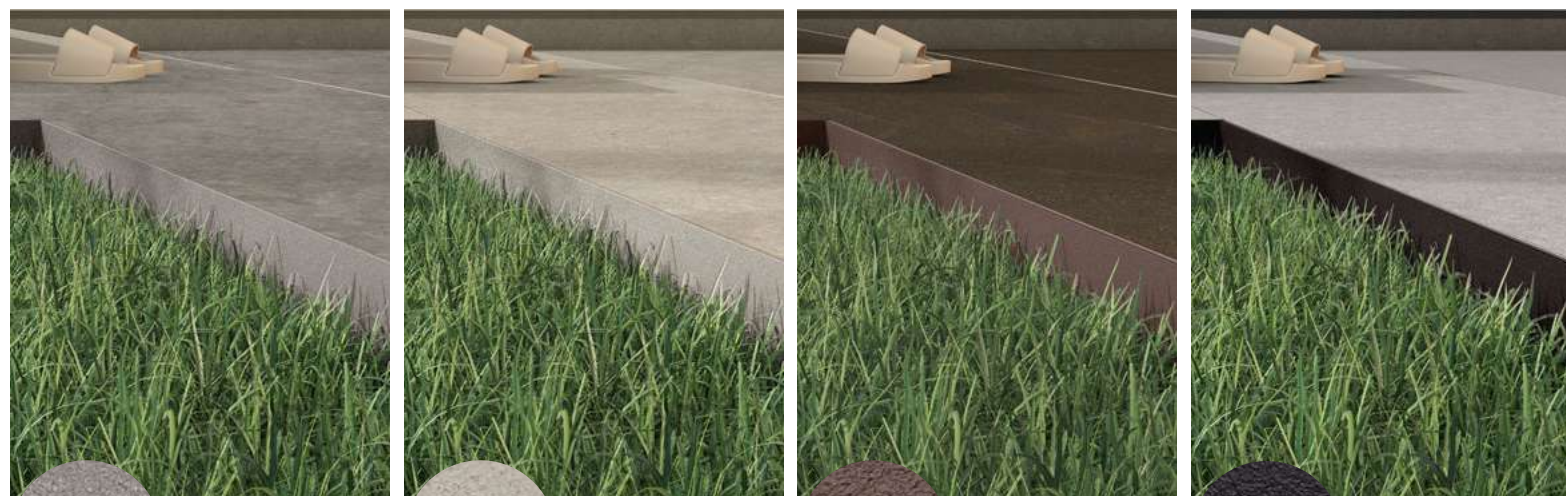

SL15
Stone grey smoke



SL04
Stone sand



SL10
Stone corten



SL12
Stone black

VARIAZIONI CROMATICHE - CHROMATIC VARIATIONS - VARIATIONS CHROMATIQUES - FARBKOMBINATIONEN

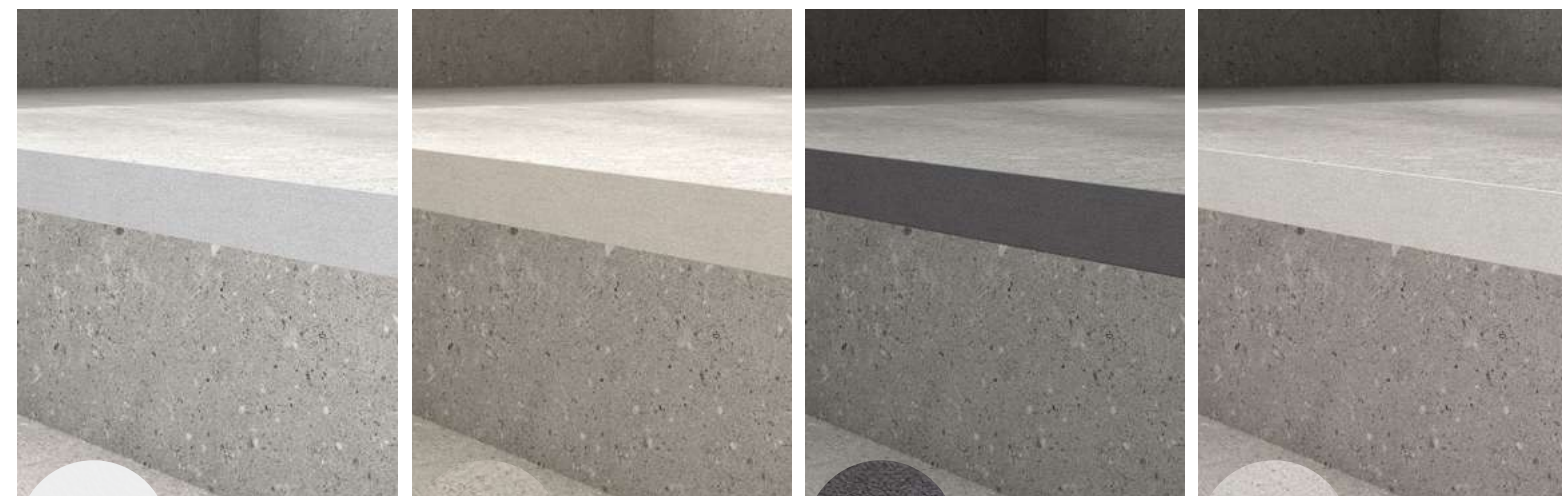

SL01
Stone white



SL04
Stone sand



SL08
Stone antrdark



SL18
Stone white cement

PROFILI PER RIVESTIMENTI - PROFILES FOR WALLS
PROFILÉS POUR RÊVÈTEMENTS - WANDVERKLEIDUNGSPROFILE

PROTERMINAL



PROJOLLY SQUARE

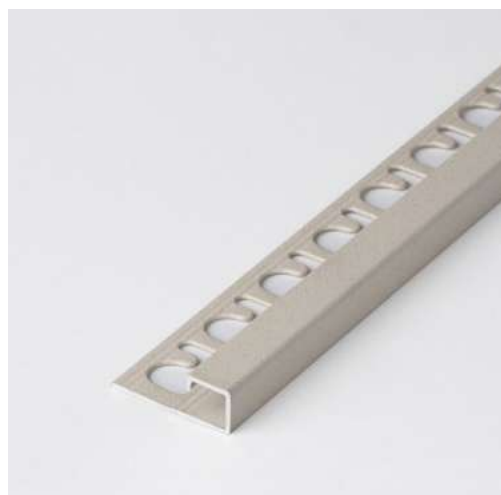

PROKERLAM LINE



PROLISTEL CHANNEL



PROJOLLY QUART



PROLISTEL P ALL



PROSHELL ALL



PROSHADOW CEILING



ACCESSORI - ACCESSORIES - ACCESSOIRES - ZUBEHÖRE



PROTERMINAL

Capsula - Capsule
Capsules - Kapseln



PROJOLLY SQUARE

Capsula - Capsule
Capsules - Kapseln



PROJOLLY QUART

Capsula - Capsule
Capsules - Kapseln



PROJOLLY SQUARE
PROJOLLY QUART

Giunzione - Joint
Raccord - Verbinder



PROJOLLY SQUARE

Tappo di chiusura - End cap
Bouchon - Endkappen

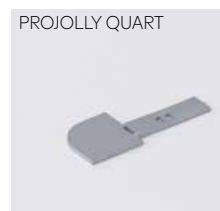

PROJOLLY QUART

Tappo di chiusura - End cap
Bouchon - Endkappen

PROFILI PER GRADINI - STAIR NOSING PROFILES - PROFILÉS POUR MARCHES - TREPPENPROFILE

DOUBLE TERMINAL



PROSHADOW STAIR & WALL

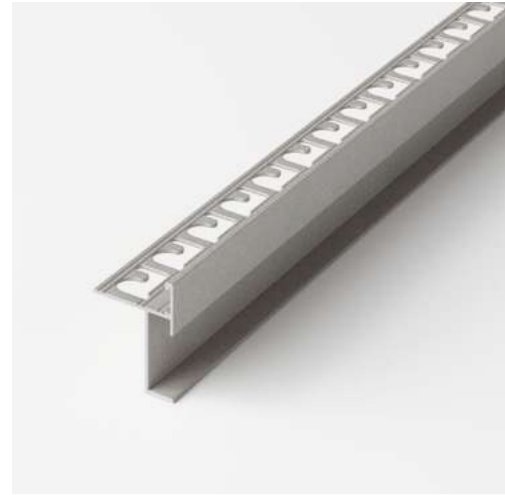

**PROFILI PER TERRAZZI - PROFILES FOR TERRACES
PROFILÉS POUR TERRASSES - PROFILE FÜR TERRASSEN**

PROTERRACE DOUBLE DRIP



PROTERRACE ECO DRIP



PROSIDE WALK



ACCESSORI - ACCESSORIES - ACCESSOIRES - ZUBEHÖRE



Angolo esterno - Internal corners
Angles externes - Aussenwinkel



Angolo interno - External corners
Angles internes - Innenwinkel



Giunzione - Joint
Raccord - Verbinder



Angolo esterno - Internal corners
Angles externes - Aussenwinkel



Giunzione - Joint
Raccord - Verbinder



Giunzione angolare esterna -
External angular junction -
Raccords à recouvrement
(angles externes) - Abdeckende
eckstücke (aussenwinkel)



Giunzione angolare interna -
Internal angular junction -
Raccords à recouvrement
(angles internes) - Abdeckende
eckstücke (innenwinkel)

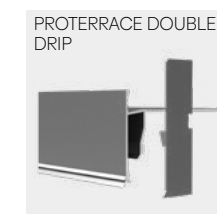

Tappo terminale - End cap
Bouchons de fermeture
Endkappen



Giunzione - Joint
Raccord - Verbinder



Angolo esterno - Internal corners
Angles externes - Aussenwinkel



Angolo interno - External corners
Angles internes - Innenwinkel

BATTISCOPA - SKIRTING BOARD - PLINTHE - SOCKELLEISTEN

BATTISCOPA SKIRTINGS 40 / 60 / 80 / 100



PROSKIRTING LIST



PROSKIRTING ROUND



PROSHADOW GAP 2513 / 2520

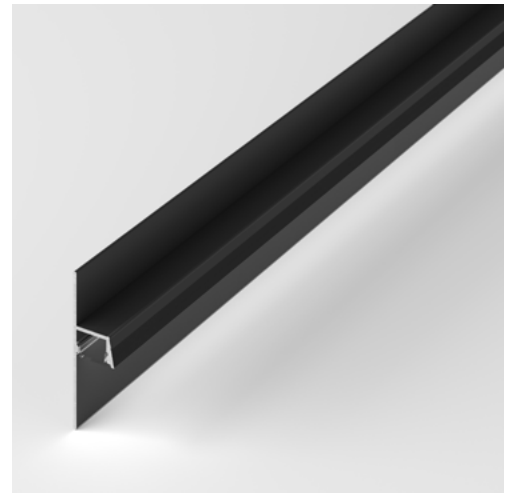

PROSHADOW GAP 25



PROSKIRTING FLAT

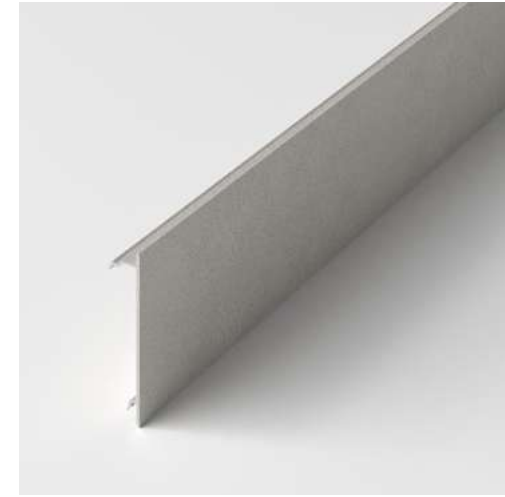

PROSKIRTING INS



PROSKIRTING LINE

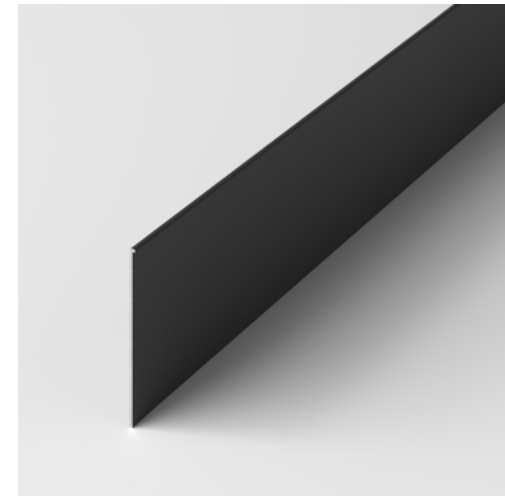

PROSKIRTING 202060



ACCESSORI - ACCESSORIES - ACCESSOIRES - ZUBEHÖRE



Angolo interno - Internal corner
Raccord interne - Innenwinkel



Angolo esterno - External corner
Raccord externe - Aussenwinkel



Raccordo - Joint
Jonction - Verbinder

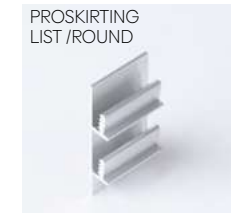

Supporto forato - Punched support
Support Percé - Gelochte Halterung



Tappo di chiusura - End cap
Bouchon - Endkappen



Tappo di chiusura - End cap
Bouchon de fermeture - Endkappen



Tappo di chiusura - End cap
Bouchon de fermeture - Endkappen

PROSHOWER PROFILE FRONT

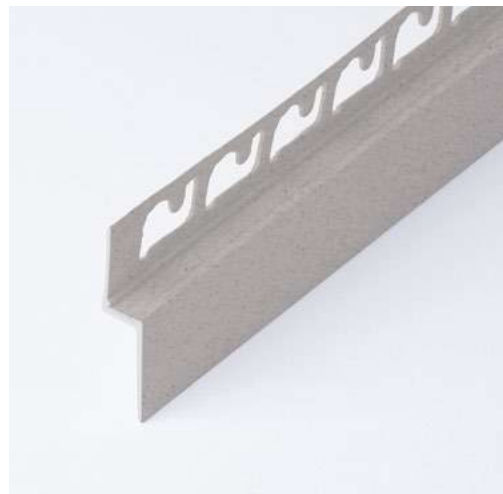

PROSHOWER PROFILE WALL

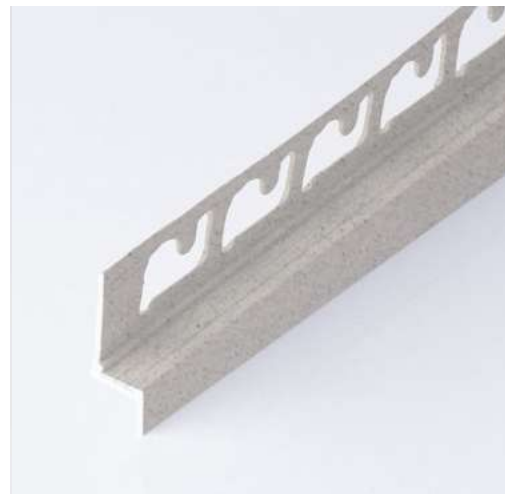

PROSHOWER PROFILE GLASS

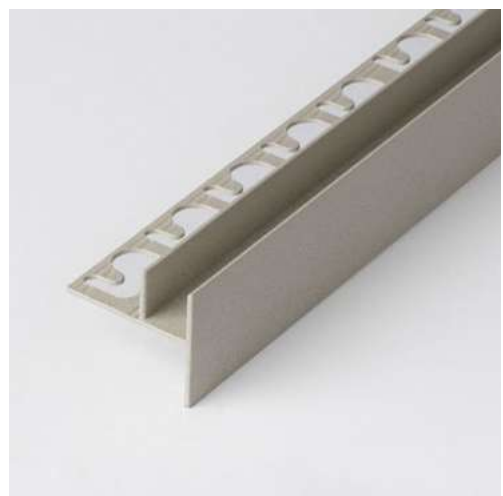

PROLISTEL CHANNEL



PRONICHE FLEX 30



PRONICHE FLEX 60



PRONICHE FLEX 120



PROSHLF INS LINE























PROSHLF INS DESIGN



STONE LINE

DISPONIBILITÀ PRODOTTI PER COLORE - PRODUCTS AVAILABILITY BY COLOUR

DISPONIBILITÉ DE PRODUITS PAR COULEUR - PRODUKTÜBERSICHT NACH FARBE

COLORI / COLOURS COULEURS / FARBEN			PROTERMINAL					PROJOLLY SQUARE					PROJOLLY QUART			PROSHELF INS DESIGN/LINE	PROLISTEL CHANNEL		PROLISTEL P ALL		PROSHADOW CEILING	PROSHADOW STAIR&WALL	DOUBLE TERMINAL	PROSHELL ALL		PROKERLAM LINE			
H / mm			6	8	10	11	12,5	6	8	10	11	12,5	8	10	12,5	-	10	12,5	10	25		-	10/20	10	12,5	6	8	10	12,5
SL01		Stone white	●	●	●	●	●	●	●	●	●	●	●	●	●	●	●	●	●	●		●	●	●	●	●	●	●	●
SL02		Stone cream	●	●	●	●	●	●	●	●	●	●	●	●	●	●	●	●	●	●			●			●	●	●	●
SL03		Stone greyvory	●	●	●	●	●	●	●	●	●	●	●	●	●	●	●	●	●	●			●			●	●	●	●
SL04		Stone sand	●	●	●	●	●	●	●	●	●	●	●	●	●	●	●	●	●	●			●	●	●				
SL05		Stone gray	●	●	●	●	●	●	●	●	●	●	●	●	●	●	●	●	●	●		●	●	●	●	●	●	●	●
SL06		Stone cristal gray	●	●	●	●	●	●	●	●	●	●	●	●	●	●	●	●	●	●									
SL13		Stone oyster grey	●	●	●	●	●	●	●	●	●	●	●	●	●	●	●	●	●	●			●						
SL08		Stone antradark	●	●	●	●	●	●	●	●	●	●	●	●	●	●	●	●	●	●		●	●	●	●	●	●	●	●
SL12		Stone black	●	●	●	●	●	●	●	●	●	●	●	●	●	●						●				●	●	●	●
SL10		Stone corten	●	●	●	●	●	●	●	●	●	●	●	●	●	●													
SL16		Stone grey gun	●	●	●	●	●	●	●	●	●	●	●	●	●	●													
SL07		Stone antragray	●	●	●	●	●	●	●	●	●	●	●	●	●	●													
SL09		Stone bronze	●	●	●	●	●	●	●	●	●	●	●	●	●	●													
SL14		Stone taupe grey	●	●	●	●	●	●	●	●	●	●	●	●	●	●													
SL15		Stone grey smoke	●	●	●	●	●	●	●	●	●	●	●	●	●	●													
SL17		Stone tobacco	●	●	●	●	●	●	●	●	●	●	●	●	●	●													
SL18		Stone white cement	●	●	●	●	●	●	●	●	●	●	●	●	●	●						●	●			●	●	●	●
SL19		Stone sahara			●					●																			
SL20		Stone cement grey																											
SL21		Stone blue grey																											

STONE LINE

DISPONIBILITÀ PRODOTTI PER COLORE - PRODUCTS AVAILABILITY BY COLOUR

DISPONIBILITÉ DE PRODUITS PAR COULEUR - PRODUKTÜBERSICHT NACH FARBE









Kateidos









COLORI / COLOURS COULEURS / FARBEN		BATTISCOPIA				PROSKIRTING LIST			PROSKIRTING ROUND			PROSHADOW GAP 25	PROSHADOW GAP 2520	PROSHADOW GAP 2513	PROSKIRTING FLAT	PROSKIRTING INS		PROSKIRTING LINE	PROSKIRTING 202060	PROSHOWER PROFILE	PROSHOWER PROFILE FRONT	PROSHOWER PROFILE WALL	PROSHOWER PROFILE GLASS	PRONICHE FLEX			PROTERRACE DOUBLE DRIP	PROTERRACE ECO DRIP	PROSIDE WALK	
		40	60	80	100	40	60	80	40	60	80	25	25	25	60	60		60	20/40	10	10	10	12,5	30	60	120	10	12,5	10	10
SL01	Stone white	●	●	●	●	●	●	●	●	●	●									●	●	●	●	●	●	●				
SL02	Stone cream																			●	●	●	●							
SL03	Stone greyvory																			●	●	●	●							
SL04	Stone sand																			●	●	●	●	●	●	●	●	●	●	●
SL05	Stone gray	●	●	●	●	●	●	●	●	●	●	●			●	●				●	●	●	●				●	●	●	●
SL06	Stone cristal gray																			●	●	●	●							
SL13	Stone oyster grey																			●	●	●	●							
SL08	Stone antradark	●	●	●	●	●			●			●								●	●	●	●							
SL12	Stone black																										●	●	●	●
SL10	Stone corten																										●	●	●	●
SL16	Stone grey gun																													
SL07	Stone antragray																													
SL09	Stone bronze																													
SL14	Stone taupe grey																													
SL15	Stone grey smoke																										●	●	●	●
SL17	Stone tobacco																													
SL18	Stone white cement	●	●	●	●	●	●	●	●	●	●	●			●	●														
SL19	Stone sahara																													
SL20	Stone cement grey																													
SL21	Stone blue grey																													

EASY LINE

DISPONIBILITÀ PRODOTTI PER COLORE - PRODUCTS AVAILABILITY BY COLOUR

DISPONIBILITÉ DE PRODUITS PAR COULEUR - PRODUKTÜBERSICHT NACH FARBE

COLORI / COLOURS COULEURS / FARBEN			PROTERMINAL					PROJOLLY SQUARE					PROJOLLY QUART			PROSHELF INS DESIGN/LINE	PROLISTEL CHANNEL		PROLISTEL P ALL		PROSHADOW CEILING	PROSHADOW STAIR&WALL	DOUBLE TERMINAL	PROSHELL ALL		PROKERLAM LINE			
H / mm			6	8	10	11	12,5	6	8	10	11	12,5	8	10	12,5	-	10	12,5	10	25	-	-	10/20	10	12,5	6	8	10	12,5
EYP01		Matt white			●				●												●	●	●	●	●				
EYP11		Matt black			●				●						●						●	●	●	●	●	●	●	●	●
EY151		Hazel brown			●				●																				
EY006		Light grey			●				●																				
EY007		Beige			●				●																				
EY008		Dark gray			●				●																				
EY009		Warm grey			●				●																				
EY110		Dark beige			●				●																				

COLORI / COLOURS COULEURS / FARBEN			BATTISCOPIA				PROSKIRTING LIST			PROSKIRTING ROUND			PROSHADOW GAP 25	PROSHADOW GAP 2520	PROSHADOW GAP 2513	PROSKIRTING FLAT		PROSKIRTING INS	PROSKIRTING LINE	PROSKIRTING 202060	PROSHOWER PROFILE	PROSHOWER PROFILE FRONT	PROSHOWER PROFILE WALL	PROSHOWER PROFILE GLASS	PRONICHE FLEX		
H / mm			40	60	80	100	40	60	80	40	60	80	25	25	25	60	60	60	20/40	10	10	10	12,5	30	60	120	
EYP01		Matt white varnished	●	●	●	●	●	●	●	●	●	●	●	●	●	●	●	●	●	●							
EYP11		Matt black varnished	●	●	●	●	●	●	●	●	●	●	●	●	●	●	●	●	●	●	●	●	●	●	●	●	●
EY151		Hazel brown																									
EY006		Light grey																									
EY007		Beige																									
EY008		Dark gray																									
EY009		Warm grey																									
EY110		Dark beige																									

PROFILI PER RIVESTIMENTI

ALLUMINIO VERNICIATO KALEIDOS

I profili per rivestimenti di finitura, disponibili in forme arrotondate, squadrate o a "L", uniscono protezione e design. Versatili e resistenti, valorizzano il dettaglio architettonico e si integrano con le tendenze ceramiche, adattandosi a spazi tradizionali e contemporanei.

PROFILES FOR WALLS

VARNISHED ALUMINIUM KALEIDOS

Finish wall profiles, available in rounded, square or "L" shapes, combine protection and design. Versatile and resistant, they enhance architectural detail and integrate with ceramic trends, adapting to traditional and contemporary spaces.

PROFILÉS POUR RÊVÈTEMENTS

ALUMINIUM LAQUÉ KALEIDOS

Les profilés pour revêtements de finition, disponibles en forme arrondie, carrée ou « L », allient protection et design. Polyvalents et résistants, ils mettent en valeur le détail architectural et s'intègrent aux tendances céramiques, s'adaptant à des espaces traditionnels et contemporains.

WANDVERKLEIDUNGSPROFILE

ALUMINIUM LACKIERT KALEIDOS

Die Abschlußprofile für Wandbeläge, erhältlich in runden, eckigen oder L-förmigen Varianten, verbinden Schutz und Design. Vielseitig und langlebig heben sie architektonische Details hervor und fügen sich harmonisch in aktuelle Keramiktrends ein, passend für traditionelle und moderne Räume.

PROKERLAM LINE

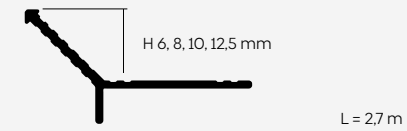

ESEMPI DI POSA - INSTALLATION EXAMPLES
EXEMPLES DE POSE - VERLEGEBEISPIELE

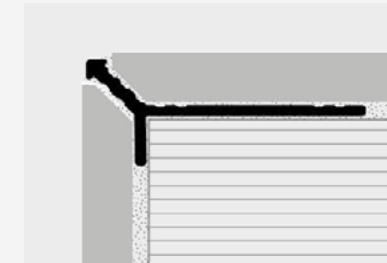

PROLISTEL CHANNEL



ESEMPI DI POSA - INSTALLATION EXAMPLES
EXEMPLES DE POSE - VERLEGEBEISPIELE

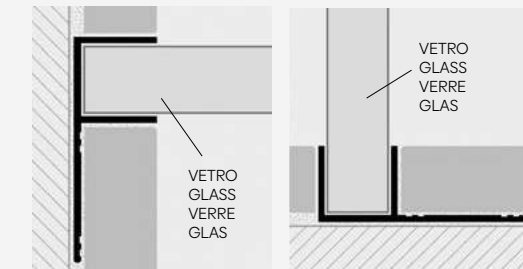

PROTERMINAL



ESEMPI DI POSA - INSTALLATION EXAMPLES
EXEMPLES DE POSE - VERLEGEBEISPIELE

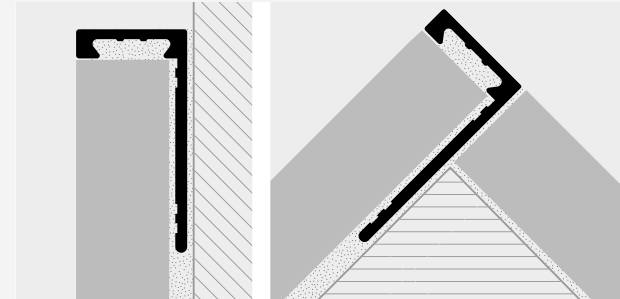

PROJOLLY SQUARE

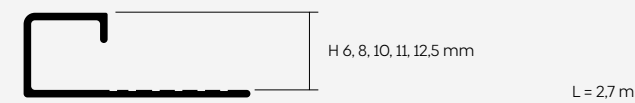

ESEMPI DI POSA - INSTALLATION EXAMPLES
EXEMPLES DE POSE - VERLEGEBEISPIELE

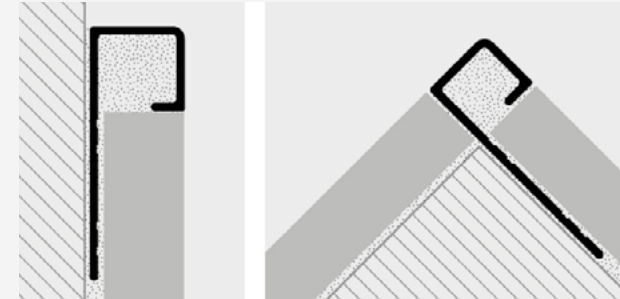

PROSHELL

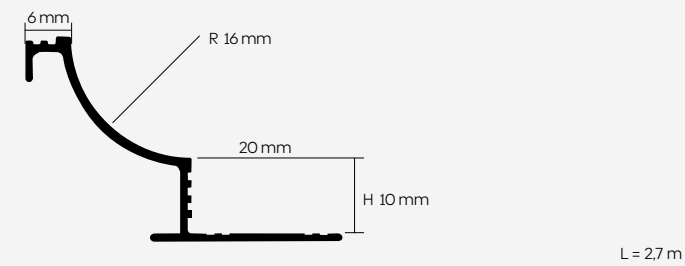

ESEMPI DI POSA - INSTALLATION EXAMPLES
EXEMPLES DE POSE - VERLEGEBEISPIELE

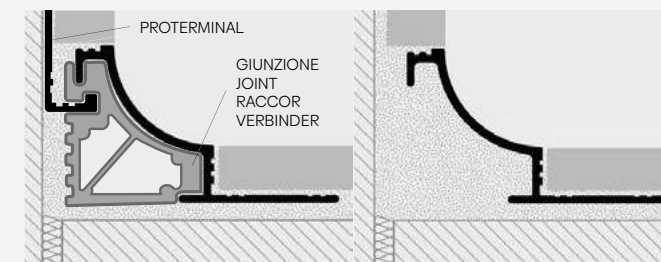

PROSHODOW CEILING

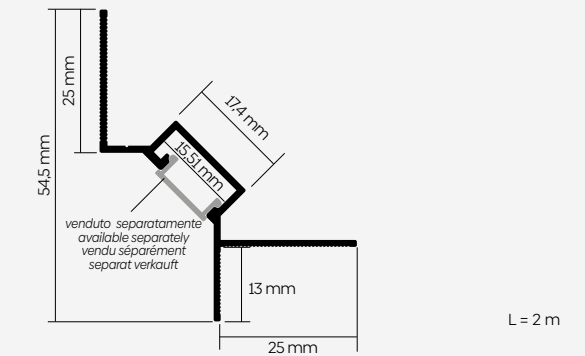

ESEMPI DI POSA - INSTALLATION EXAMPLES
EXEMPLES DE POSE - VERLEGEBEISPIELE

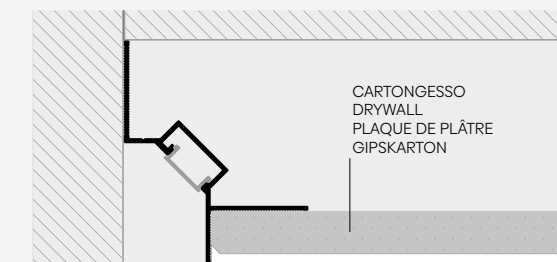

PROJOLLY QUART

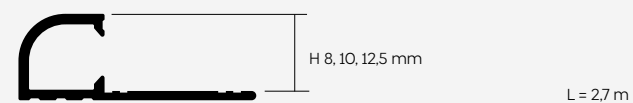

ESEMPI DI POSA - INSTALLATION EXAMPLES
EXEMPLES DE POSE - VERLEGEBEISPIELE

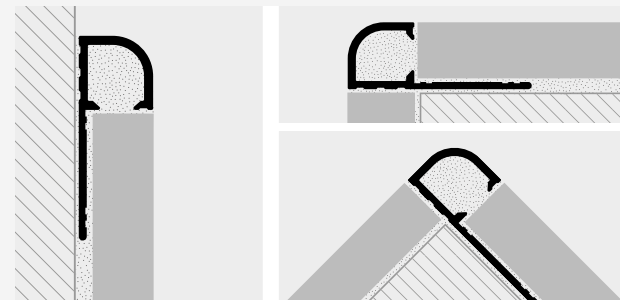

PROLISTEL P ALL

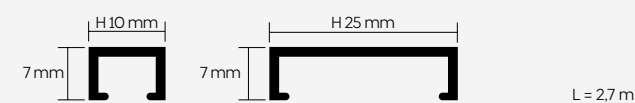

ESEMPI DI POSA - INSTALLATION EXAMPLES
EXEMPLES DE POSE - VERLEGEBEISPIELE

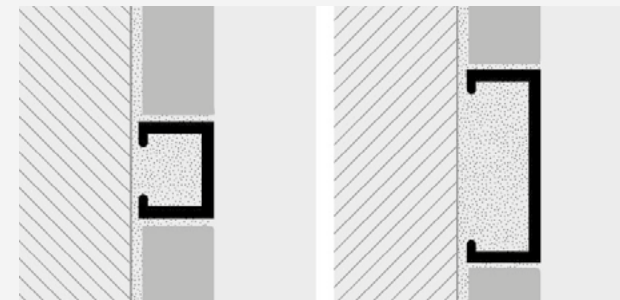

PROFILI PER GRADINI

ALLUMINIO VERNICIATO KALEIDOS

Progress Profiles amplia le finiture ai profili per gradini, con soluzioni che uniscono protezione dei bordi ceramici e continuità estetica nello stile Kaleidos. I nuovi modelli preservano lo spigolo e valorizzano l'elemento architettonico, integrandosi con pavimentazioni e rivestimenti. Oltre alle soluzioni tecniche di sicurezza, sono disponibili varianti con LED integrati che rendono il gradino un dettaglio luminoso e scenografico per progetti contemporanei.

STAIR NOSING PROFILES

VARNISHED ALUMINIUM KALEIDOS

Progress Profiles expands finishes to step profiles, with solutions that combine ceramic edge protection and aesthetic continuity in the Kaleidos style. The new models preserve the edge and enhance the architectural element, integrating with floors and walls. In addition to technical safety solutions, variants with integrated LEDs that make the step a bright and scenic detail for contemporary projects are also available.

PROFILÉS POUR MARCHES
ALUMINIUM LAQUÉ KALEIDOS

Progress Profiles étend les finitions aux profilés pour marches, avec des solutions qui combinent protection des bords céramiques et continuité esthétique dans le style Kaleidos. Les nouveaux modèles préservent l'arête et mettent en valeur l'élément architectural, en s'intégrant avec les sols et les murs. En plus des solutions techniques de sécurité, il existe des variantes avec LED intégrées qui font de la marche un détail lumineux et scénographique pour les projets contemporains.

TREPPENPROFILE
ALUMINIUM LACKIERT KALEIDOS

Progress Profiles erweitert das Sortiment der Stufenprofile mit Lösungen, die Schutz der Keramikanten und ästhetische Kontinuität im Kaleidos-Stil vereinen. Die neuen Modelle schützen die Kante und betonen das architektonische Element, dabei fügen sie sich harmonisch in Bodenbeläge und Wandverkleidungen ein. Neben den technischen Sicherheitslösungen sind auch Versionen mit integrierten LEDs verfügbar, die die Stufe zu einem leuchtenden und inszenierten Detail für zeitgenössische Projekte machen.

DOUBLE TERMINAL

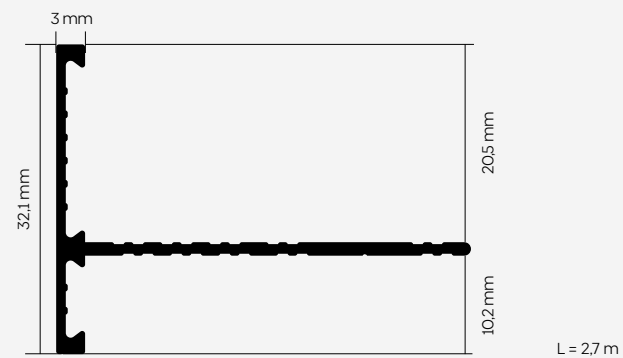

ESEMPI DI POSA - INSTALLATION EXAMPLES
EXEMPLES DE POSE - VERLEGEBEISPIELE

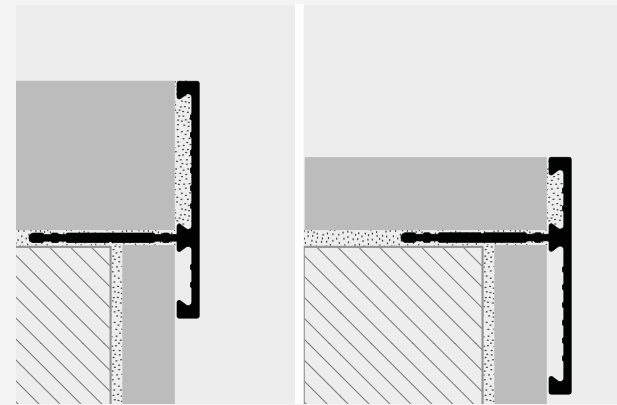

PROSHADOW STAIR & WALL

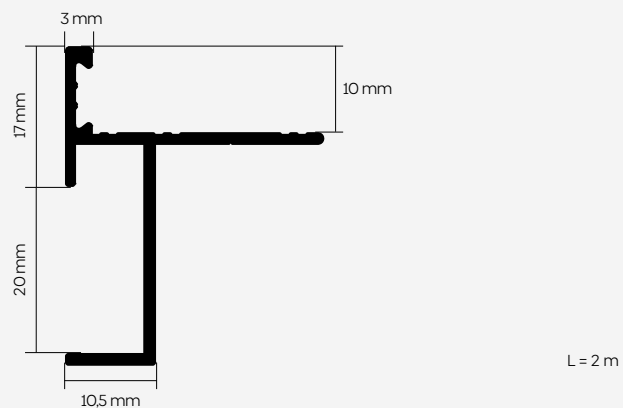

ESEMPI DI POSA - INSTALLATION EXAMPLES
EXEMPLES DE POSE - VERLEGEBEISPIELE

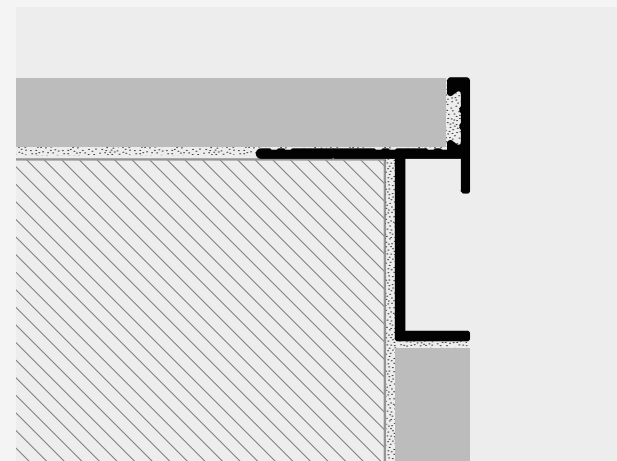

PROFILI PER TERRAZZI

ALLUMINIO VERNICIATO KALEIDOS

Profili perimetrali brevettati, in alluminio verniciato, studiati per proteggere i bordi delle piastrelle e per garantire un corretto deflusso delle acque su terrazzi, balconi e marciapiedi, in caso di pioggia, umidità, infiltrazioni. Offrono un alto grado di personalizzazione giocando sulle diverse nuance di colore in modo da creare una perfetta continuità con gli interni.

PROFILES FOR TERRACES

VARNISHED ALUMINIUM KALEIDOS

Patented perimeter profiles, in painted aluminum, designed to protect the edges of the tiles and to ensure proper water flow on terraces, balconies and sidewalks, in case of rain, humidity, infiltration. They offer a high degree of customization by playing on the different colour nuances so as to create perfect continuity with the interiors.

PROFILÉS POUR TERRASSES
ALUMINIUM LAQUÉ KALEIDOS

Profilés périmétriques brevetés, en aluminium verni, conçus pour protéger les bords des carreaux et pour garantir un écoulement correct de l'eau sur les terrasses, balcons et trottoirs, en cas de pluie, d'humidité, d'infiltrations. Ils offrent un haut degré de personnalisation en jouant sur les différentes nuances de couleur afin de créer une parfaite continuité avec l'intérieur.

PROFILE FÜR TERRASSEN
ALUMINIUM LACKIERT KALEIDOS

Patentierte Randabschlussprofile aus lackiertem Aluminium, entwickelt zum Schutz der Fliesenanten und zum fachgerechtem Wasserablauf auf Terrassen, Balkonen und Gehwegen bei Regen, Feuchtigkeit oder Eindringen von Wasser. Sie bieten ein hohes Maß an Individualisierung durch verschiedene Farbnuancen, um eine perfekte Kontinuität zum Innenbereich zu schaffen.

PROTERRACE DOUBLE DRIP

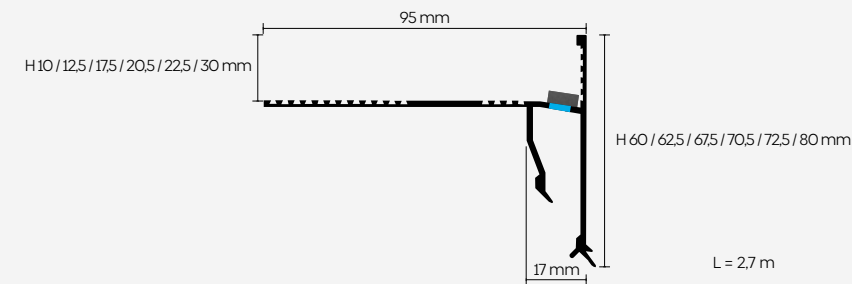

ESEMPI DI POSA - INSTALLATION EXAMPLES
EXEMPLES DE POSE - VERLEGEBEISPIELE

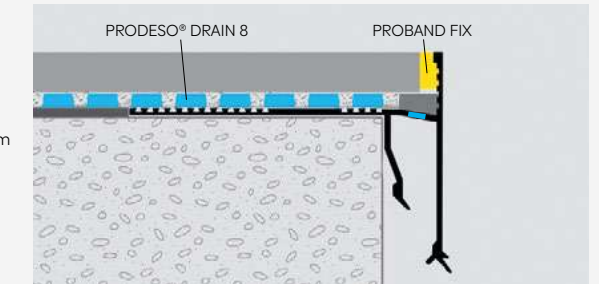

PROTERRACE ECO DRIP

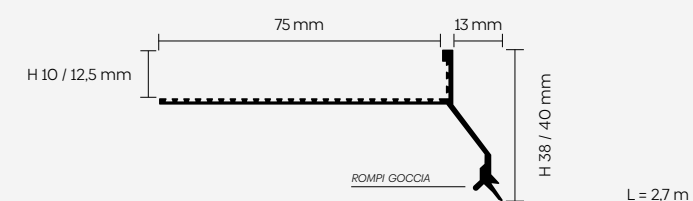

ESEMPI DI POSA - INSTALLATION EXAMPLES
EXEMPLES DE POSE - VERLEGEBEISPIELE

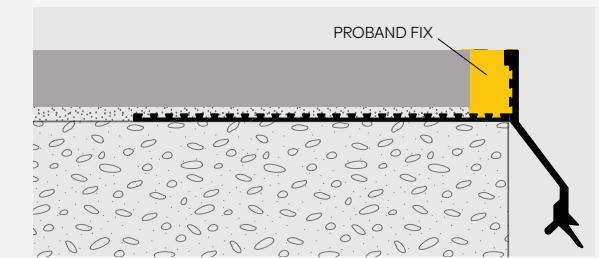

PROSIDE WALK

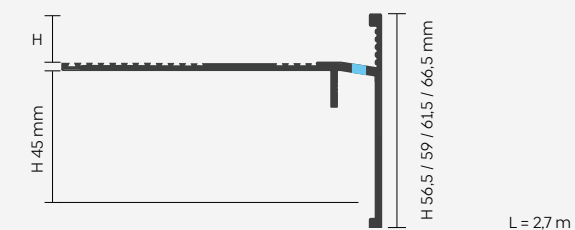

ESEMPI DI POSA - INSTALLATION EXAMPLES
EXEMPLES DE POSE - VERLEGEBEISPIELE

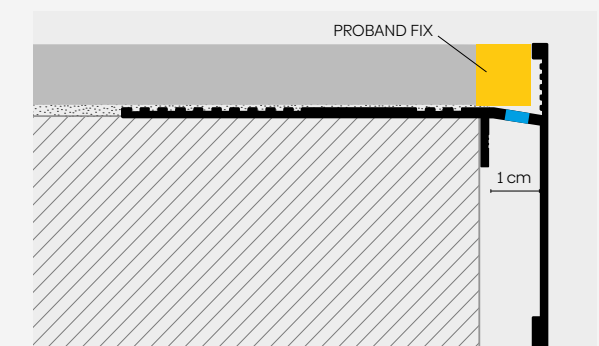

BATTISCOPIA

ALLUMINIO VERNICIATO KALEIDOS

I battiscopa in alluminio, disponibili in molteplici soluzioni e varianti di finitura, si affiancano ai modelli evoluti con illuminazione LED integrata. Questi elementi trasformano la funzione tecnica in dettaglio progettuale, dialogando con le nuove tendenze dell'architettura e con i grandi classici dell'arredo. Versatili e resistenti, consentono di disegnare spazi abitativi e lavorativi con eleganza, stile e creatività, valorizzando ogni ambiente interno attraverso luce e materia.

SKIRTING BOARD

VARNISHED ALUMINIUM KALEIDOS

Aluminum skirting boards, available in multiple solutions and finishing variations, are alongside the advanced models with integrated LED lighting. These elements transform the technical function into design detail, engaging with new architectural trends and the great classics of furniture. Versatile and durable, they allow you to design living and working spaces with elegance, style and creativity, enhancing each inte.

PLINTHE
ALUMINIUM LAQUÉ KALEIDOS

Les plinthes en aluminium, disponibles dans de multiples solutions et variantes de finition, s'ajoutent aux modèles évolués avec éclairage LED intégré. Ces éléments transforment la fonction technique en détail de conception, dialoguant avec les nouvelles tendances de l'architecture et avec les grands classiques du mobilier. Polyvalents et résistants, ils permettent de concevoir des espaces d'habitation et de travail avec élégance, style et créativité, en valorisant chaque espace intérieur à travers la lumière et la matière.

SOCKELLEISTEN
ALUMINIUM LACKIERT KALEIDOS

Aluminiumsockelleisten, erhältlich in zahlreichen Ausführungen und Oberflächenvarianten, ergänzen die weiterentwickelten Modelle mit integrierter LED-Beleuchtung. Diese Elemente verwandeln die technische Funktion in ein Gestaltungselement und stehen im Dialog mit aktuellen Architekturtrends, sowie den klassischen Einrichtungslösungen. Vielseitig und langlebig ermöglichen sie die Gestaltung von Wohn- und Arbeitsräumen mit Eleganz, Stil und Kreativität und werten jeden Innenbereich durch Licht und Materialwirkung auf.

PROSHADOW GAP 2513 / 2520

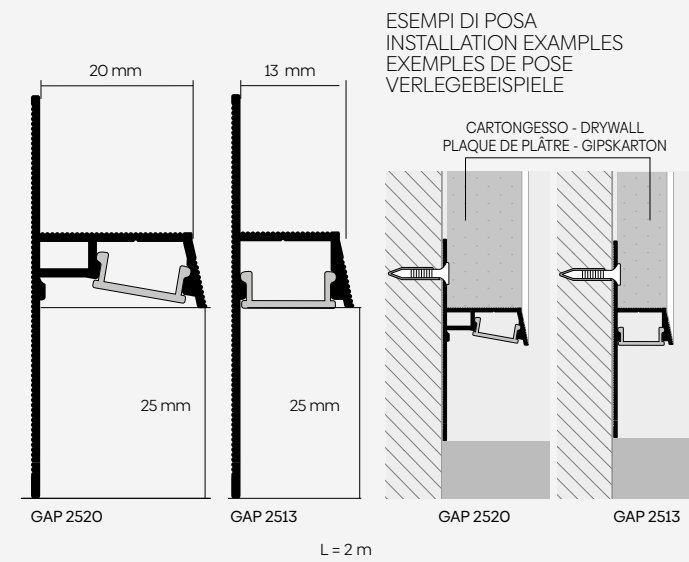

PROSHADOW GAP 25

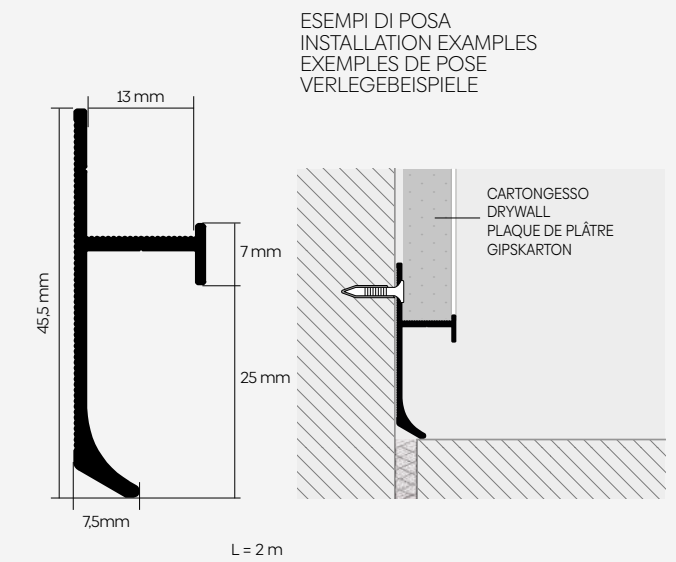

BATTISCOPIA 40 / 60 / 80 / 100

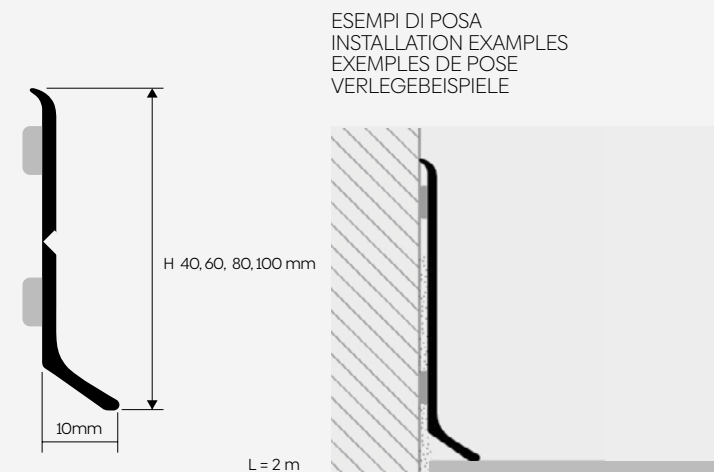

PROSKIRTING FLAT

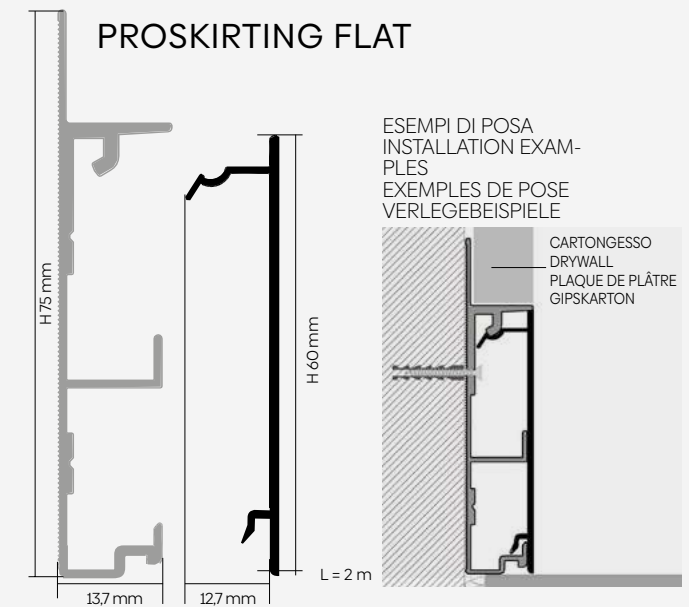

PROSKIRTING INS

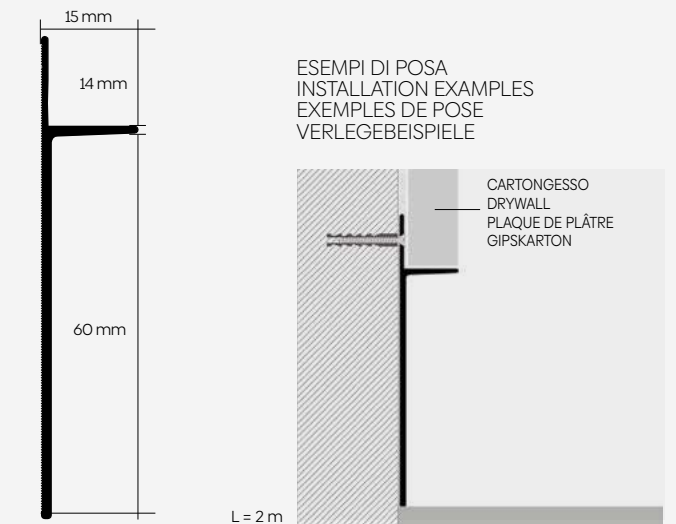

PROSKIRTING LIST

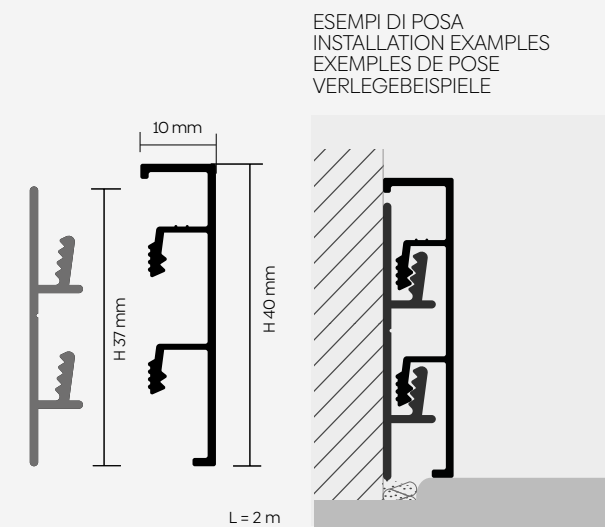

PROSKIRTING ROUND

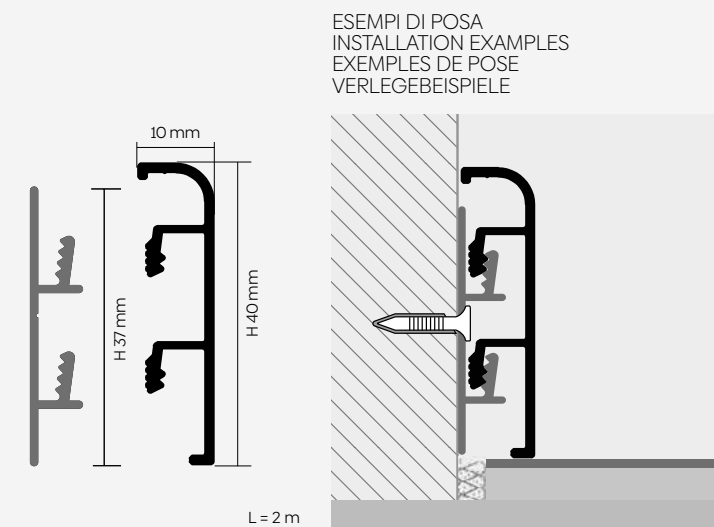

PROSKIRTING LINE

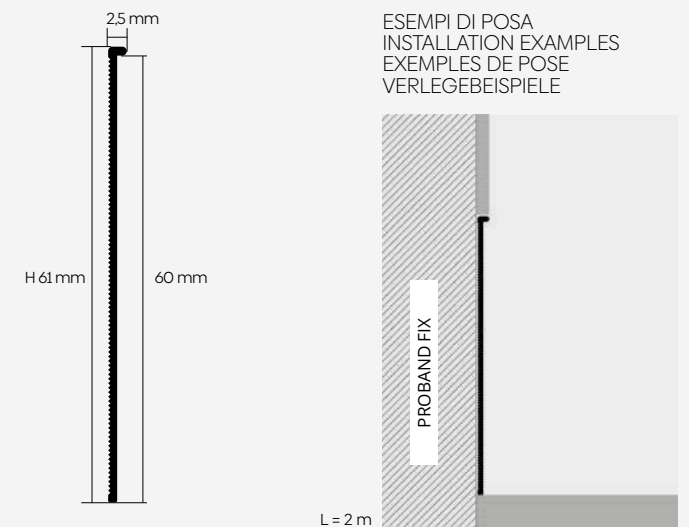

PROSKIRTING 202060

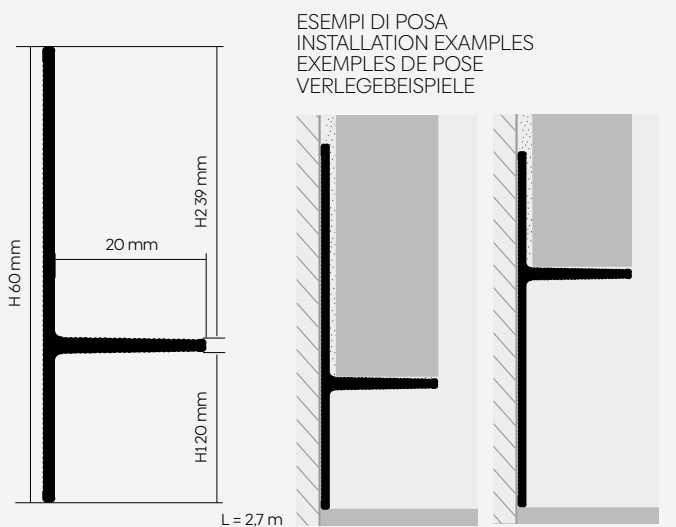

PROFILI E ACCESSORI PER DOCCE

ALLUMINIO VERNICIATO KALEIDOS

Profili in alluminio di nuova generazione per l'ambiente bagno coniugano prestazioni elevate e design raffinato, garantendo la protezione di angoli e bordi delle piastrelle nelle docce pendenziate e aree soggette a umidità e usura. Il tratto minimalista e sofisticato si integra con qualsiasi stile d'arredo grazie alle finiture Kaleidos, caratterizzate da tonalità calde e naturali. Il coordinamento tra mensole, profili per docce e nicchie nella stessa gamma assicura continuità estetica e un risultato di alto valore progettuale.

SHOWER PROFILES AND ACCESSORIES

VARNISHED ALUMINIUM KALEIDOS

Next generation aluminum bathroom profiles combine high performance and refined design, ensuring the protection of tile corners and edges in showers with slope and areas with moisture and wear. The minimalist and sophisticated feature integrates with any decor style thanks to the Kaleidos finishes, characterized by warm and natural tones. Coordination between shelves, shower profiles and niches in the same range ensures aesthetic continuity and a result of high design value.

PROFILÉS ET ACCESSOIRES POUR DOUCHE

ALUMINIUM LAQUÉ KALEIDOS

Les profilés en aluminium de nouvelle génération pour la salle de bain allient performances élevées et design raffiné, garantissant la protection des angles et bords des carreaux dans les douches avec pente et les zones avec humidité et usure. Le trait minimaliste et sophistiqué s'intègre à n'importe quel style d'ameublement grâce aux finitions Kaleidos, caractérisées par des tons chauds et naturels. La coordination entre les étagères, les profilés pour douches et les niches dans la même gamme assure une continuité esthétique et un résultat de haute valeur conceptuelle.

PROFILE UND ZUBEHÖR FÜR DUSCHE

ALUMINIUM LACKIERT KALEIDOS

Aluminiumprofile der neuen Generation für das Badezimmer, hohe Leistungsfähigkeit mit anspruchsvollem Design verbinden. Sie schützen Ecken und Kanten der Fliesen in Duschbereichen sowie in feuchtigkeits- und beanspruchungsempfindlichen Zonen. Die minimalistische und elegante Formensprache fügt sich dank der Kaleidos-Oberflächen - geprägt von warmen und natürlichen Farbtönen - in jeden Einrichtungsstil ein. Die Abstimmung zwischen Ablagen, Duschprofile und Nischen innerhalb der gleichen Produktlinie gewährleistet ästhetische Kontinuität und ein Ergebnis von hohem gestalterischem Wert.

PROSHOWER PROFILE WALL

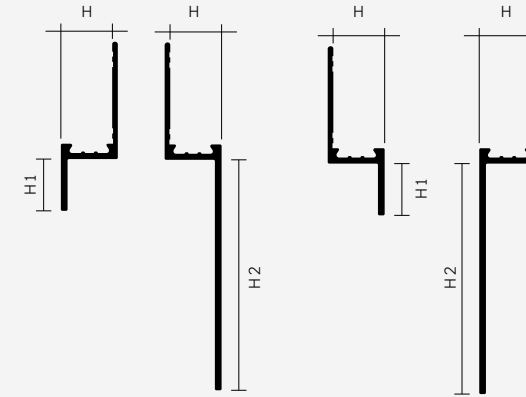

ESEMPI DI POSA - INSTALLATION EXAMPLES
EXEMPLES DE POSE - VERLEGEBEISPIELE

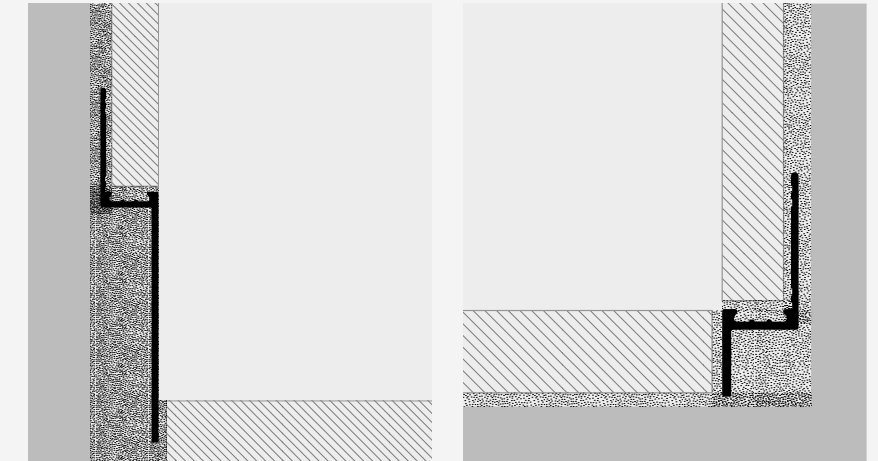

PROSHOWER PROFILE

ESEMPI DI POSA - INSTALLATION EXAMPLES
EXEMPLES DE POSE - VERLEGEBEISPIELE

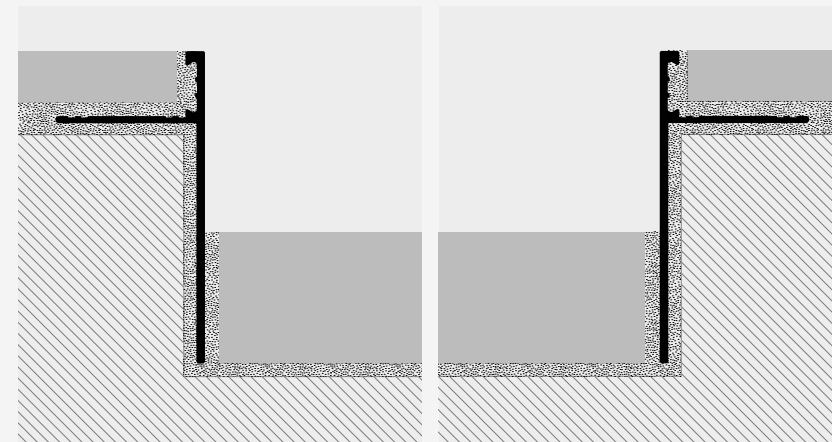
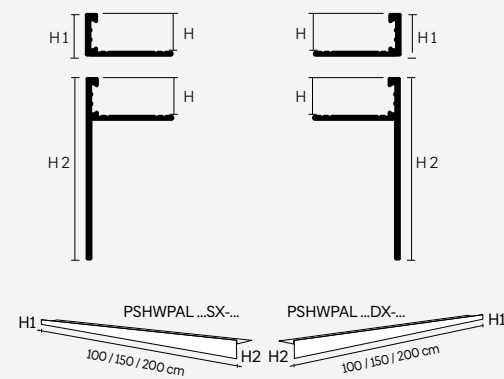

PROSHOWER PROFILE GLASS

ESEMPI DI POSA - INSTALLATION EXAMPLES
EXEMPLES DE POSE - VERLEGEBEISPIELE

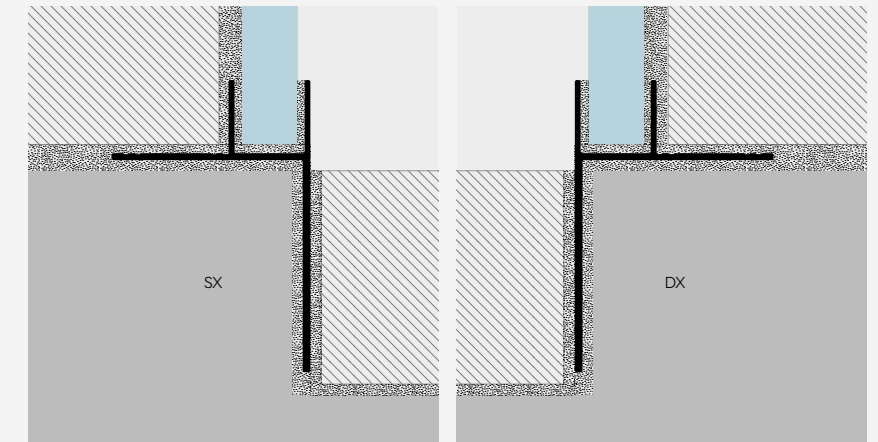
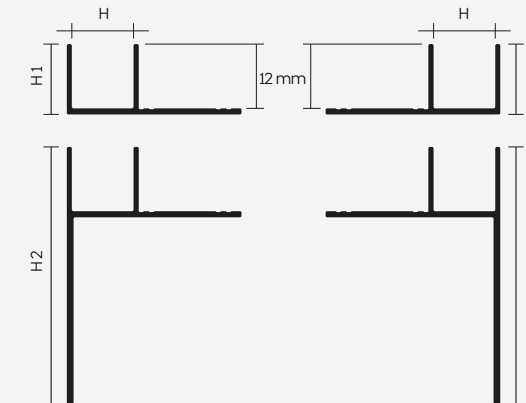

PROSHOWER PROFILE FRONT

ESEMPI DI POSA - INSTALLATION EXAMPLES
EXEMPLES DE POSE - VERLEGEBEISPIELE

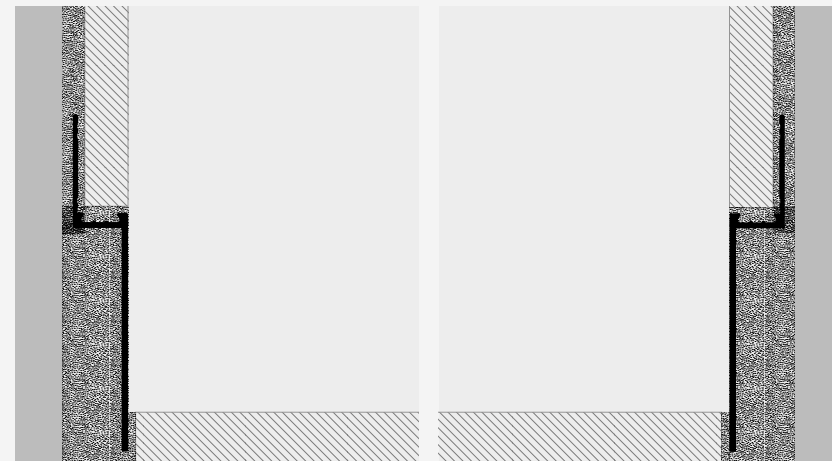
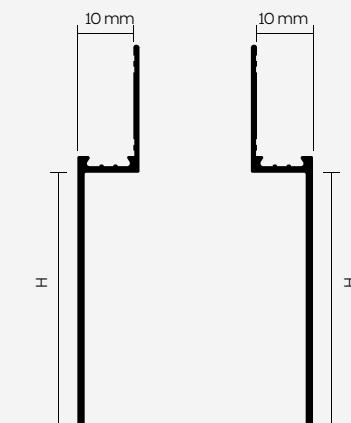

MISURE DISPONIBILI - AVAILABLE MEASURES
MESURES DISPONIBLES - VERFÜGBARE MASSNAHMEN

PROSHOWER PROFILE

H mm	H1 mm	H2 mm	L cm
10	11	28	100
10	11	38	150
10	11	48	200
10	11	28	100
10	11	38	150
10	11	48	200

PROSHOWER PROFILE GLASS

H mm	H1 mm	H2 mm	L cm
12.5	13.7	30	100
12.5	13.7	40	150
12.5	13.7	50	200
12.5	13.7	30	100
12.5	13.7	40	150
12.5	13.7	50	200

PROSHOWER PROFILE FRONT

H mm	H1 mm	L cm
10	28	100
10	38	100
10	48	100
10	28	150
10	38	150
10	48	150

PROSHOWER PROFILE WALL

H mm	H1 mm	H2 mm	L cm
10	10	28	100
10	10	38	150
10	10	48	200
10	10	28	100
10	10	38	150
10	10	48	200

PROFILI E ACCESSORI PER DOCCE - SHOWER PROFILES AND ACCESSORIES
 PROFILÉS ET ACCESSOIRES POUR DOUCHE - PROFILE UND ZUBEHÖR FÜR DUSCHE

PRONICHE FLEX 30

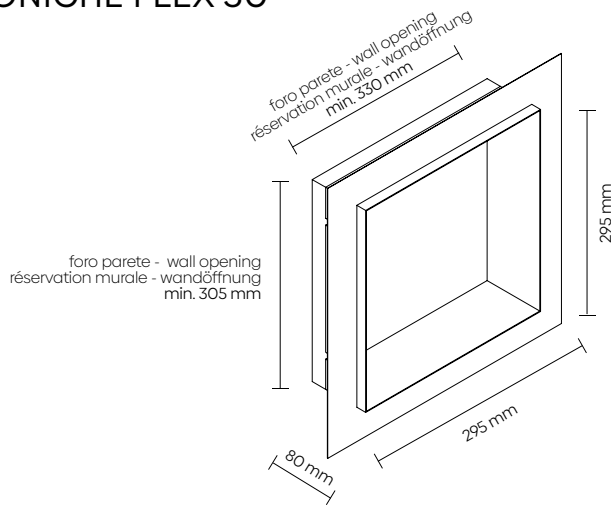

PRONICHE FLEX 120

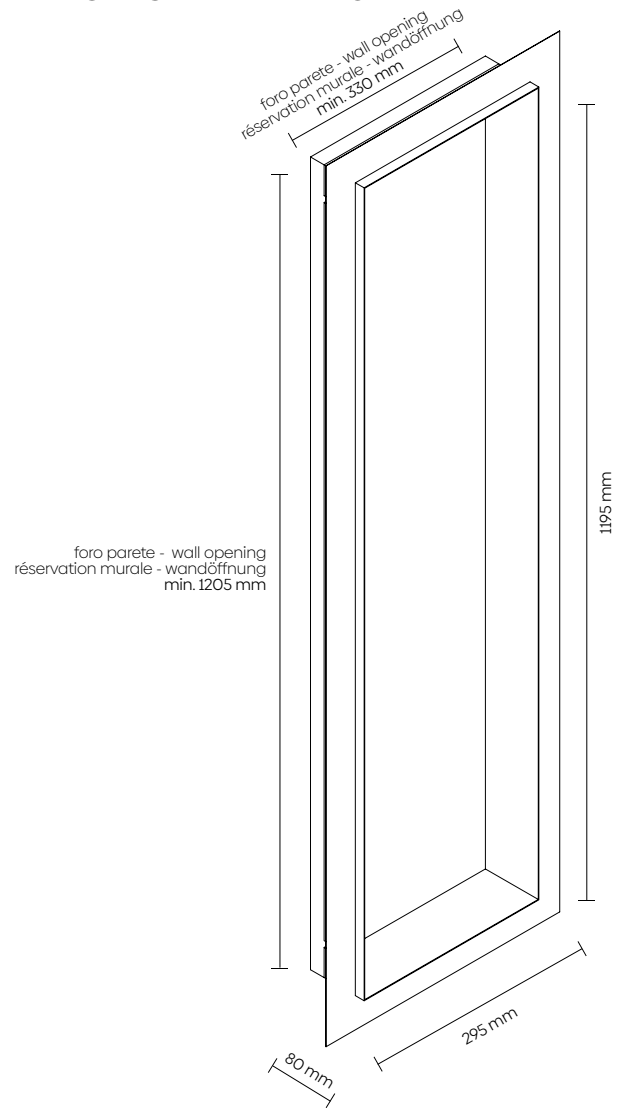

PRONICHE FLEX 60

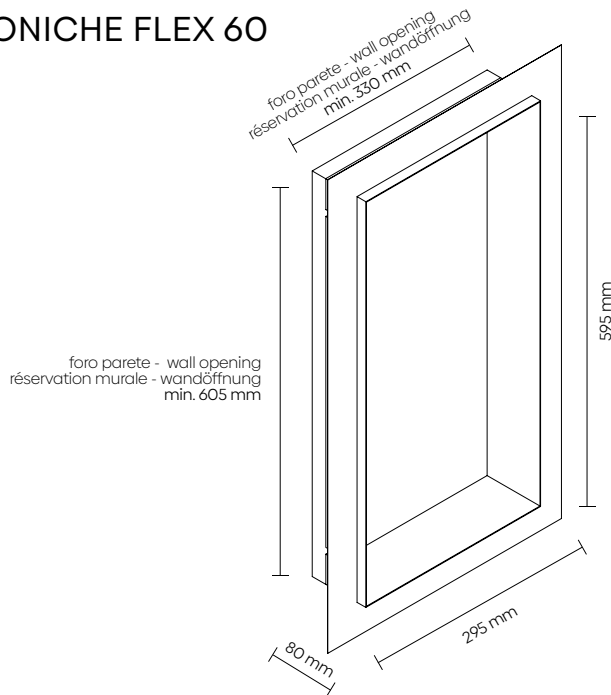

PROSHLF INS

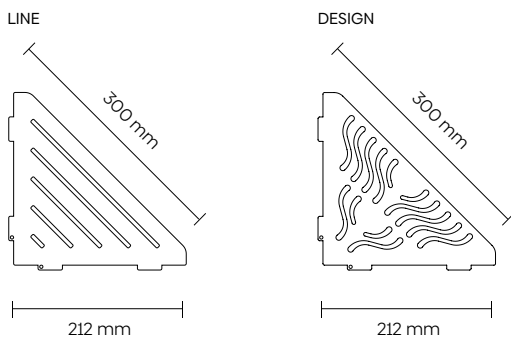

ESEMPI DI POSA - INSTALLATION EXAMPLES
 EXEMPLES DE POSE - VERLEGEBEISPIELE

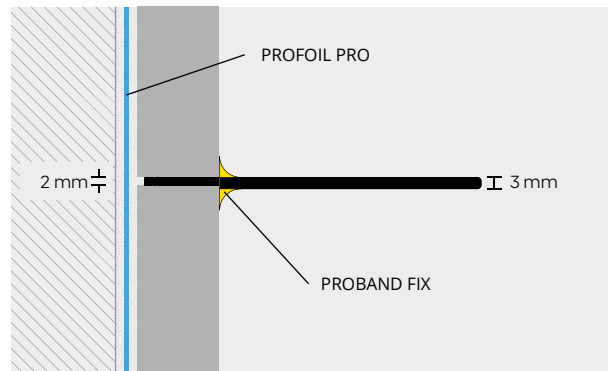

Sede/Headquarter
Progress Profiles SpA
Via Le Marze 7
31011 ASOLO (TV) Italy
Tel. +39 0423 950398
Azienda certificata
UNI EN ISO 9001:2015
info@progressprofiles.com

Filiale / Branch Office & Warehouse
Progress Profiles America Inc.
750 Veterans Pkwy.
Bolingbrook, Illinois 60440
U.S.A
Tel. 001 973 584 2650
usa@progressprofiles.com

Filiale / Branch Office & Warehouse
Progress Profiles Middle East LLC
Al khitab st.
Al Nahyan
Abu Dhabi, U.A.E
P.O.BOX: 29101
Tel. 00971-26 730 411
uae@progressprofiles.com

Filiale / Branch Office & Warehouse
Progress Profiles Middle East LLC
AL QUOZ INDUSTRIAL FOURTH
26th Street, Showroom No. 1
Dubai, U.A.E.
P.O. BOX: 29101
Tel. 00971-04 325 1499
uae@progressprofiles.com

